

Echo[®] Bi-Metric[®] Microplasty[®] Hip Stem

Surgical Technique



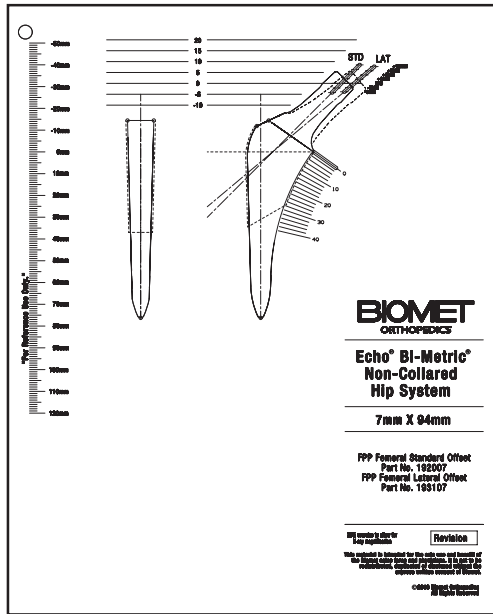

Figure 1

Preoperative Planning

Preoperative templates are provided for determining optimal component size, femoral neck resection level and appropriate neck length (Figure 1). Radiographs should include a full A/P (anteroposterior) view of the pelvis including the proximal one-half of both femurs and a lateral view of the proximal half of the affected femur.

When preoperative planning, ensure that the stem will achieve proximal fixation before distal contact with cortical bone.

The Echo Bi-Metric Microplasty Stem was designed and developed in conjunction with David Dodgin, M.D.; James Dowd, M.D.; Henry Finn, M.D.; John Meding, M.D. and Herrick Siegel, M.D.

This Echo Bi-Metric Microplasty Stem pre-operative planning and surgical technique is utilized by the surgeons listed above. Biomet, as the manufacturer of this device, does not practice medicine. Each surgeon is responsible for determining the appropriate device and technique to utilize on each individual patient.

Manual Preoperative Planning

Preoperative planning can be easily performed with the Echo Bi-Metric Microplasty X-ray templates. These templates are positioned over the A/P X-rays to best decide the correct implant size and center of rotation. It is recommended to use a radiographic marker to assess the X-ray magnification and select the appropriate template.

Digital Preoperative Planning

The Echo Bi-Metric Microplasty templates are available through various digital template providers. When using digital templates, it is necessary to use a magnification marker with a known dimension to calibrate the image.

Once the correct magnification has been determined, the digital templating system can be used to best decide the correct implant required to help restore the patient's natural anatomy.

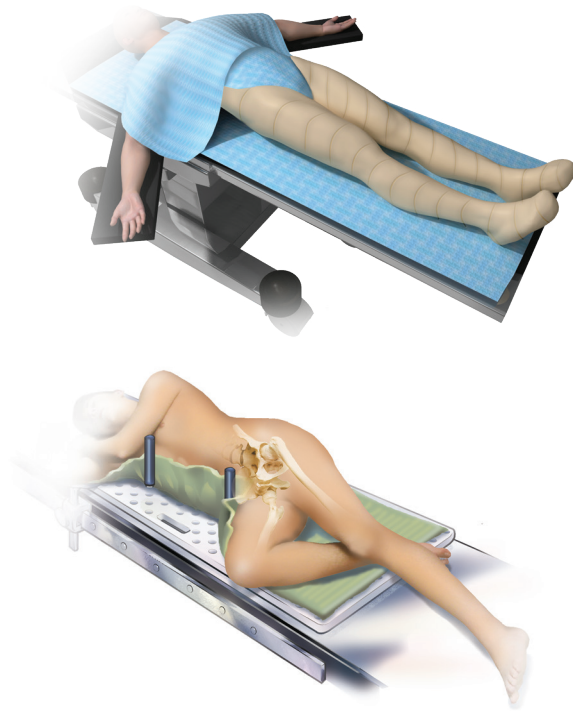

Figure 2



Figure 3

Surgical Approach

The goal of the surgical approach is to establish adequate visualization of the anatomy to evaluate stability and leg length. A number of surgical approaches to the hip can be utilized based on the degree of surgical experience and preference, such as the supine or anterolateral approach (Figure 2).

Femoral Head Resection

Once the hip has been dislocated, complete the femoral neck resection. If needed, a femoral neck resection guide is available. Place the guide over the neck, parallel to the longitudinal axis of the femur. Then, move the guide along this axis to match the resection level determined by preoperative templating and make the appropriate neck resection.

Accessing the Femoral Canal

Use the straight or offset box chisel to access the femoral canal through the lateral section of the proximal femur. The design of the straight or offset box chisel provides adequate visualization of the femur to avoid varus positioning with proper lateralization of the initial femoral canal opening (Figure 3).

- ⓘ **Note:** The size 7 broach has additional proximal lateral teeth that can aid in lateralization.
- ⓘ **Note:** If utilizing the posterior or lateral surgical approach, a single starter/lateralizer reamer on a T-handle may be used to initiate the opening into the femoral canal and lateralize the broach at insertion. This reamer was designed for posterior and lateral surgical approaches only. It is not recommended for use with an anterior approach.



Figure 4



Figure 5

Broaching the Proximal Femur

When preparing the proximal femur, use care with the insertion and removal of each broach to avoid rotation and to preserve the version of the femoral canal. Orientation of the broach should take into account the M/L and A/P position of the medullary canal. Insert the broach into the femoral envelop.

Select the smallest sized Echo Bi-Metric Microplasty broach, attach it to the broach handle and insert the broach into the femoral envelop (Figure 4). Progressively increase the broach size to enlarge the canal until the broach engages the medial and lateral cortex and cannot be advanced deeper or until the templated implant size is reached.

With the properly sized broach in place, plane the calcar flush by using the retractable calcar planer (Figure 5).

- ⓘ **Note:** When impacting the broach handle, ensure that impaction occurs on the strike plate.
- ⓘ **Note:** If the final broach size is less than the templated size, carefully determine that the broach is achieving a tight proximal fit and is not in varus position.

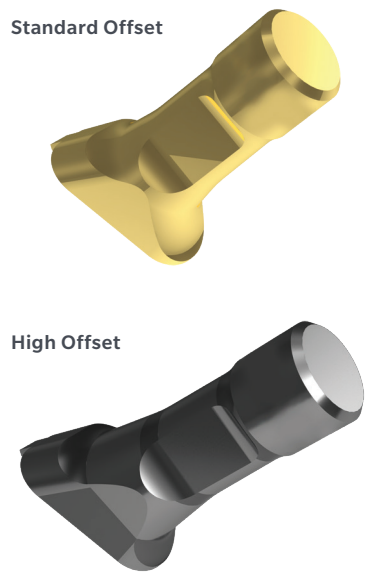

Figure 6

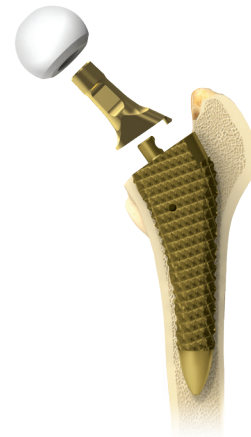

Figure 7

Trial Reduction

To perform the trial reduction with the final broach still in place, attach the appropriate Echo Bi-Metric trunnion over the extended broach post. The gold trunnion represents standard offset, while the black trunnion represents high offset (Figure 6). The Echo Bi-Metric trunnions are sized to correspond to the appropriate broach size, with the stem size clearly marked on top of the trunnion.

Select the trial femoral head of desired diameter and neck length (Figure 7). Reduce the hip to ensure that proper leg length and joint stability have been achieved. When performing the trial range of motion, ensure the femoral neck does not impinge on the rim of the acetabular component or acetabular liner.



Figure 8



Figure 9



Figure 10

Stem Insertion

Select the Echo Bi-Metric Microplasty femoral implant that corresponds to the size of the final broach. Using the blunt tip stem inserter, insert the femoral implant into the femoral envelop (Figure 8). The stem should slide distally into the canal without much resistance until it is 5–10 mm proximal to the calcar. As resistance is met, gently tap the inserter until the implant is seated.

If desired, another trial reduction can be performed prior to selecting final head size and impacting the modular head onto the stem. Provisional heads allow an additional trial reduction using the actual implant to allow for proper assessment of leg length and stability. After fully seating the femoral component, position the modular head onto a dry and clean trunnion.

Fully seat the modular head by means of firm axial impaction utilizing the femoral head pusher and mallet (Figure 9).

Component Removal

Should an Echo Bi-Metric Microplasty femoral component ever require removal, utilize the stem extraction instruments (Figure 10).

ⓘ **Note:** The implant cannot be reused once removed.

Implants

Echo Bi-Metric Microplasty Stem — Standard 135° Neck Angle

Product	Description	Size	Coating	Offset	Taper Design	Part Number
	Echo Bi-Metric Microplasty Full Proximal Profile Stem	7	PPS® (Porous Plasma Spray) Coating	Standard Offset	Type 1	193007
		8				193008
		9				193009
		10				193010
		11				193011
		12				193012
		13				193013
		14				193014
		15				193015
		16				193016
		17				193017
		18				193018
		19				193019
		20				193020
		21				193021

Echo Bi-Metric Microplasty Stem — High Offset 130° Neck Angle

Product	Description	Size	Coating	Offset	Taper Design	Part Number
	Echo Bi-Metric Microplasty Full Proximal Profile Stem	7	PPS Coating	High Offset	Type 1	193107
		8				193108
		9				193109
		10				193110
		11				193111
		12				193112
		13				193113
		14				193114
		15				193115
		16				193116
		17				193117
		18				193118
		19				193119
		20				193120
		21				193121

Implants (cont.)

Echo Bi-Metric Microplasty Stem — Standard 135° Neck Angle

Product	Description	Size	Coating	Offset	Taper Design	Part Number
	Echo Bi-Metric Microplasty Reduced Proximal Profile Stem	7	PPS Coating	Standard	Type 1	192807*
		8		Offset		192808*

Echo Bi-Metric Microplasty Stem — High Offset 130° Neck Angle

Product	Description	Size	Coating	Offset	Taper Design	Part Number
	Echo Bi-Metric Microplasty Reduced Proximal Profile Stem	7	PPS Coating	High	Type 1	192907*
		8		Offset		192908*



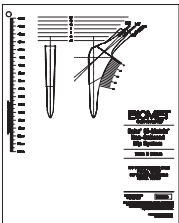

Echo Bi-Metric Microplasty Stem X-ray Templates

Product	Description	Magnification	Part Number
	Echo Bi-Metric Microplasty Stem X-ray Templates	120%	XR193108-1
		115%	XR193108-3
		110%	XR193108-2
		100%	XR193108-4

*Separate ordering is required.

Instruments





Echo Bi-Metric Microplasty Femoral Instruments

Product	Description	Size	Part Number
	Echo Bi-Metric Microplasty Instrument Case		110025763
	Echo Bi-Metric Microplasty Reduced Proximal Profile (RPP) Broach/Provisional	7	110025088*
		8	110025100*
	Echo Bi-Metric Microplasty Full Proximal Profile (FPP) Broach/Provisional	7	110025573
		8	110025574
		9	110025575
		10	110025576
		11	110025577
		12	110025578
		13	110025579
		14	110025580
		15	110025581
		16	110025582
		17	110025583
	Echo Bi-Metric Slim Trunnion Provisional Standard Offset	7-10 mm	110025749
		11-14 mm	110025750
		15-21 mm	110025751
	Echo Bi-Metric Slim Trunnion Provisional High Offset	7-10 mm	110025752
		11-14 mm	110025753
		15-21 mm	110025754
	Blunt Tip Stem Inserter		110025765

*Separate ordering is required.

Instruments

General Femoral Instruments

Product	Description	Size	Part Number
	General Femoral Instrument Tray		110026862
	Reamer T-Handle		31-473620
	Straight Starter Reamer		428195
	Modular Box Chisel		31-555588
	Calcar Planner	42mm	31-473794
	Head Impactor		31-399999





Instruments (cont.)

Additional General Femoral Instruments

Note: Instruments listed below must be ordered separately and are designed to fit into the General Femoral Instrument Tray 110026862

Product	Description	Size	Part Number
	Bi-Metric IM Resection Guide		X31-400003
	Exact™ Cork Screw		31-555605
	Exact Hollow Chisel		31-473678
	Femoral Starter		51-222221
	Straight Exact Broach Handle		31-555500
	Exact Calcar Rasp Style Blade	38 mm	31-473795
		42 mm	31-473796
		46 mm	31-473797
	Exact Calcar Blade	38 mm	406661
		42 mm	406662
		46 mm	406663
	Lateralizing Reamer		31-555583

Femoral Stem Removal Instruments



Product	Description	Part Number
	J-hook Stem Extractor	X31-400059
	Extended Stroke Slap Hammer	X31-400061
	Stem/Broach Straight Removal Adaptor	X31-400001
	Universal Broken Thread Extractor	31-478350

Instruments (cont.)

Head Provisionals

Product	Description	Size	Part Number
	Head Provisional Type 1 Half Tray (Empty)		110002768
	28 mm Type 1 Provisional Head	+9 mm	010002486
		+6 mm	010002487
		+3 mm	010002488
		Std (0 mm)	010002489
		-3 mm	010002490
		-6 mm	010002491
	32 mm Type 1 Provisional Head	+9 mm	010002493
		+6 mm	010002494
		+3 mm	010002495
		Std (0 mm)	010002496
		-3 mm	010002497
		-6 mm	010002498
	36 mm Type 1 Provisional Head	+9 mm	010002500
		+6 mm	010002501
		+3 mm	010002502
		Std (0 mm)	010002503
		-3 mm	010002504
		-6 mm	010002505

Optional Head Provisionals









Product	Description	Size	Part Number
	40 mm Type 1 Provisional Head	+9 mm	010002507
		+6 mm	010002508
		+3 mm	010002509
		Std (0 mm)	010002510
		-3 mm	010002511
		-6 mm	010002512
	44 mm Type 1 Provisional Head	+9 mm	010002514
		+6 mm	010002515
		+3 mm	010002516
		Std (0 mm)	010002517
		-3 mm	010002518
		-6 mm	010002519

Instruments (cont.)

Microplasty ASI (Anterior Supine Intermuscular) Instrumentation

Product	Description	Part Number
	Microplasty ASI Instrument Case	595292
	Cork Screw Attachment	31-555605
	Head Reducer	31-139255
	Supine Version Guide with Attachments	31-434546
	Femoral Starter Rasp	31-555402
	Offset Inserter Handle	31-555525
	Microplasty Ligamentum Cutter	31-555537
	Anterior Extractor Handle	31-555528
	Anterior Extractor Handle Adaptor	31-555529
	Modular Hollow Chisel	31-555588

Instruments (cont.)

Product	Description	Part Number
	Exact Offset Broach Handle	31-555501
	Dual Offset Broach Handle-Left	31-555405
	Dual Offset Broach Handle-Right	31-555406
	Flat Hohmann Retractor	31-555536
	DeWitte Retractor	31-555535
	Mueller Acetabular Retractor	31-555534
	Large Hohmann Retractor	31-555533
	Cobra Retractor	31-555532
	Femoral Elevator	31-555531

Additional Instrument Option

Product	Description	Part Number
	Modified #5 ASI Retractor	31-555594

Offsets and Neck Lengths

Standard Offset Echo Bi-Metric Microplasty Stem

Size	Stem Length (mm)	Neck Angle	Horizontal Offset (mm)							Vertical Offset (mm)							Neck Length (mm)						
			-6	-3	STD	+3	+6	+9	+12	-6	-3	STD	+3	+6	+9	+12	-6	-3	STD	+3	+6	+9	+12
7	94	135	32.8	34.9	37	39.1	41.2	43.4	45.5	27.2	29.3	31.4	33.5	35.6	37.8	39.9	27.8	30.8	33.8	36.8	39.8	42.8	45.8
8	96.5	135	33.1	35.2	37.3	39.4	41.5	43.7	45.8	27.3	29.4	31.5	33.6	35.7	37.9	40	27.8	30.8	33.8	36.8	39.8	42.8	45.8
9	99	135	33.4	35.5	37.6	39.7	41.8	44	46.1	27.4	29.5	31.6	33.7	35.8	38	40.1	27.7	30.7	33.7	36.7	39.7	42.7	45.7
10	101.5	135	33.7	35.8	37.9	40	42.1	44.3	46.4	27.5	29.6	31.7	33.8	35.9	38.1	40.2	27.7	30.7	33.7	36.7	39.7	42.7	45.7
11	104	135	35.7	37.8	39.9	42	44.1	46.3	48.4	28.5	30.6	32.7	34.8	36.9	39.1	41.2	29.4	32.4	35.4	38.4	41.4	44.4	47.4
12	106.5	135	36	38.1	40.2	42.3	44.4	46.6	48.7	28.6	30.7	32.8	34.9	37	39.2	41.3	29.4	32.4	35.4	38.4	41.4	44.4	47.4
13	109	135	36.3	38.4	40.5	42.6	44.7	46.9	49	28.7	30.8	32.9	35	37.1	39.3	41.4	29.4	32.4	35.4	38.4	41.4	44.4	47.4
14	111.5	135	36.6	38.7	40.8	42.9	45	47.2	49.3	28.8	30.9	33	35.1	37.2	39.4	41.5	29.4	32.4	35.4	38.4	41.4	44.4	47.4
15	114	135	38.6	40.7	42.8	44.9	47	49.2	51.3	29.8	31.9	34	36.1	38.2	40.4	42.5	31.1	34.1	37.1	40.1	43.1	46.1	49.1
16	116.5	135	38.9	41	43.1	45.2	47.3	49.5	51.6	29.9	32	34.1	36.2	38.3	40.5	42.6	31.1	34.1	37.1	40.1	43.1	46.1	49.1
17	119	135	39.2	41.3	43.4	45.5	47.6	49.8	51.9	30	32.1	34.2	36.3	38.4	40.6	42.7	31	34	37	40	43	46	49
18	121.5	135	39.5	41.6	43.7	45.8	47.9	50.1	52.2	30.1	32.2	34.3	36.4	38.5	40.7	42.8	31	34	37	40	43	46	49
19	124	135	39.8	41.9	44	46.1	48.2	50.4	52.5	30.2	32.3	34.4	36.5	38.6	40.8	42.9	31	34	37	40	43	46	49
20	126.5	135	40.1	42.2	44.3	46.4	48.5	50.7	52.8	30.3	32.4	34.5	36.6	38.7	40.9	43	30.9	33.9	36.9	39.9	42.9	45.9	48.9
21	129	135	40.4	42.5	44.6	46.7	48.8	51	53.1	30.4	32.5	34.6	36.7	38.8	41	43.1	30.9	33.9	36.9	39.9	42.9	45.9	48.9

High Offset Echo Bi-Metric Microplasty Stem

Size	Stem Length (mm)	Neck Angle	Horizontal Offset (mm)							Vertical Offset (mm)							Neck Length (mm)						
			-6	-3	STD	+3	+6	+9	+12	-6	-3	STD	+3	+6	+9	+12	-6	-3	STD	+3	+6	+9	+12
7	94	130	38.4	40.7	43	45.3	47.6	49.9	52.2	27.5	29.5	31.4	33.3	35.3	37.2	39.1	32	35	38	41	44	47	50
8	96.5	130	38.7	41	43.3	45.6	47.9	50.2	52.5	27.6	29.6	31.5	33.4	35.4	37.3	39.2	32	35	38	41	44	47	50
9	99	130	39	41.3	43.6	45.9	48.2	50.5	52.8	27.7	29.7	31.6	33.5	35.5	37.4	39.3	32	35	38	41	44	47	50
10	101.5	130	39.3	41.6	43.9	46.2	48.5	50.8	53.1	27.8	29.8	31.7	33.6	35.6	37.5	39.4	32	35	38	41	44	47	50
11	104	130	41.3	43.6	45.9	48.2	50.5	52.8	55.1	28.8	30.8	32.7	34.6	36.6	38.5	40.4	33.7	36.7	39.7	42.7	45.7	48.7	51.7
12	106.5	130	41.6	43.9	46.2	48.5	50.8	53.1	55.4	28.9	30.9	32.8	34.7	36.7	38.6	40.5	33.7	36.7	39.7	42.7	45.7	48.7	51.7
13	109	130	41.9	44.2	46.5	48.8	51.1	53.4	55.7	29	31	32.9	34.8	36.8	38.7	40.6	33.7	36.7	39.7	42.7	45.7	48.7	51.7
14	111.5	130	42.2	44.5	46.8	49.1	51.4	53.7	56	29.1	31.1	33	34.9	36.9	38.8	40.7	33.6	36.6	39.6	42.6	45.6	48.6	51.6
15	114	130	44.2	46.5	48.8	51.1	53.4	55.7	58	30.1	32.1	34	35.9	37.9	39.8	41.7	35.4	38.4	41.4	44.4	47.4	50.4	53.4
16	116.5	130	44.5	46.8	49.1	51.4	53.7	56	58.3	30.2	32.2	34.1	36	38	39.9	41.8	35.4	38.4	41.4	44.4	47.4	50.4	53.4
17	119	130	44.8	47.1	49.4	51.7	54	56.3	58.6	30.3	32.3	34.2	36.1	38.1	40	41.9	35.3	38.3	41.3	44.3	47.3	50.3	53.3
18	121.5	130	45.1	47.4	49.7	52	54.3	56.6	58.9	30.4	32.4	34.3	36.2	38.2	40.1	42	35.3	38.3	41.3	44.3	47.3	50.3	53.3
19	124	130	45.4	47.7	50	52.3	54.6	56.9	59.2	30.5	32.5	34.4	36.3	38.3	40.2	42.1	35.2	38.2	41.2	44.2	47.2	50.2	53.2
20	126.5	130	45.7	48	50.3	52.6	54.9	57.2	59.5	30.6	32.6	34.5	36.4	38.4	40.3	42.2	35.2	38.2	41.2	44.2	47.2	50.2	53.2
21	129	130	46	48.3	50.6	52.9	55.2	57.5	59.8	30.7	32.7	34.6	36.5	38.5	40.4	42.3	35.2	38.2	41.2	44.2	47.2	50.2	53.2

The Echo Bi-Metric Microplasty Hip Stems are designed for use with compatible Zimmer and Biomet modular heads and/or acetabular components for total hip or hemi hip arthroplasty. Biomet has evaluated the compatibility of Biomet devices with implants and components from Zimmer orthopedic companies. Only authorized combinations should be used. To determine whether these devices have been authorized for use in a proposed combination with Zimmer products, please contact your sales representative and reference the following website: www.productcompatibility.zimmer.com.

INDICATIONS

1. Non-inflammatory degenerative joint disease including osteoarthritis and avascular necrosis.
2. Rheumatoid arthritis.
3. Correction of functional deformity.
4. Treatment of non-union, femoral neck fracture, and trochanteric fractures of the proximal femur with head involvement, unmanageable using other techniques.
5. Revision of previously failed total hip arthroplasty.

Porous coated components are intended for uncemented, biological fixation.

CONTRAINDICATIONS

Absolute contraindications include: infection, sepsis, and osteomyelitis.

Relative contraindications include:

1. Uncooperative patient or patient with neurologic disorders who are incapable of following directions,
2. Osteoporosis,
3. Metabolic disorders which may impair bone formation,
4. Osteomalacia,
5. Distant foci of infections which may spread to the implant site,
6. Rapid joint destruction, marked bone loss or bone resorption apparent on roentgenogram,
7. Vascular insufficiency, muscular atrophy, or neuromuscular disease.

All content herein is protected by copyright, trademarks and other intellectual property rights owned by or licensed to Zimmer Biomet or its affiliates unless otherwise indicated, and must not be redistributed, duplicated or disclosed, in whole or in part, without the express written consent of Zimmer Biomet.

This material is intended for the sole use and benefit of the Zimmer Biomet sales force and health care professionals distribution to any other recipient is prohibited.

For complete product information regarding indications, contraindications, precautions, warnings and sterilization, see the instructions for use packaged with the device, which can also be located on www.zimmerbiomet.com.

© 2015, 2021 Zimmer Biomet



0056.2-US-en-Issue Date-2021-11-10

 **Legal Manufacturer**
Biomet Orthopedics
P.O. Box 587
56 E. Bell Drive
Warsaw, Indiana 46581-0587
USA

www.zimmerbiomet.com

CE2797

CE mark on a surgical technique is not valid unless there is a CE mark on the product label.