



Persona[®] Revision Knee System

Persona Primary to Revision
Femoral Conversion

Surgical Technique

Table of Contents

Quick Reference	1
Abbreviated Surgical Technique	
Introduction	2
Device Description	2
Persona Primary Tibial Preparation	2
Odd Sized Persona Primary to Odd Sized Persona Revision Femoral Conversion	3
Even Sized Persona Primary to Odd Sized Persona Revision Femoral Conversion	3
Anterior Referencing	
Posterior Referencing	
Tapered Stem Preparation	4
Femoral Provisional Assembly and Insertion	5
Femoral Box Cut Preparation	6
Optional Femoral Box Cut Preparation Using the Notch Cut Guide	
Trial Reduction	7
TASP Assembly	
CPS and CCK Bearing TASP Assembly	
TASP Shim Exchange	
TASP Removal	
Flexion and Extension Gap Analysis	
Patella Resurfacing	10
Final Trialing	10
Implant Assembly	11
Tibial Implant Assembly	
Femoral Implant Assembly	
Two Stage Cementing Technique	12
Tibial Cementing Technique	
Femoral Cementing Technique	
Bearing Assembly and Insertion	14
CCK Bearing Insert Assembly	
PS, CPS and CCK Bearing Assembly	
CCK Bearing Lockdown Screw Assembly	
Close Incision	16
Component Removal	16
PS, CPS and CCK Bearing Removal	
Tibial Baseplate Component Removal	
Femoral Component Removal	
Compatibility Charts	17

Quick Reference: Abbreviated Surgical Technique



Step 1:
Femoral Size Conversion



Step 2:
Tapered Stem Preparation



Step 3:
Femoral Provisional Assembly
and Insertion



Step 4:
Femoral Box Cut Preparation



Step 5: Trial Reduction
(TASP)



Step 6:
Patella Resurfacing



Step 7:
Final Trialing



Step 8:
Implant Assembly



Step 9:
Component Implantation

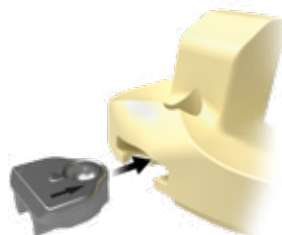

Step 10:
Bearing Assembly
and Insertion



Step 11:
Close Incision

ⓘ **Note:** Do not use implants and/or instruments from other knee systems unless expressly labeled for such use.

ⓘ **Note:** A stem extension implant must be utilized with the femoral component.

ⓘ **Note:** If a Constrained Condylar Knee (CCK) bearing is being utilized, a tibial stem extension is required.

ⓘ **Note:** The Persona Revision Femoral Component is not compatible with the Persona Primary Trabecular Metal™ Tibial Component.

Introduction

If during a Persona Primary Arthroplasty, the knee requires more constraint using a constrained condylar knee (CCK) bearing and/or added fixation with a stemmable femoral option, intraoperative conversion to a Persona Revision Femoral Component may be necessary. The following technique should be utilized to convert both the standard and narrow Persona Primary Femurs to a Persona Revision Femoral Component.

Device Description

The Persona Revision Knee System is designed for use in both complex primary and revision arthroplasty. Persona Revision Knee System is a constrained revision knee prosthesis consisting of anatomically designed components including:

- Femoral Components
- Articular Surfaces (Bearings)
- Tibial Baseplates
- Stem Extensions
- Femoral and Tibial Augments
- Femoral and Tibial Trabecular Metal Cones

Persona Primary Tibial Preparation

To prepare the tibia, reference the Persona Primary Surgical Technique 97-5026-001-00 and the Persona Primary 14 mm x +30 mm Stem Extension Surgical Technique 97-5026-037-00.

ⓘ **Note:** Tibial slope must be cut at 3 degrees to accommodate the Posterior Stabilized (PS), Constrained Posterior Stabilized (CPS) and Constrained Condylar Knee (CCK) bearings.

ⓘ **Note:** If converting from a Cruciate Retaining (CR) bearing, ensure a 3 degree cut block is available.



Figure 1



Figure 3

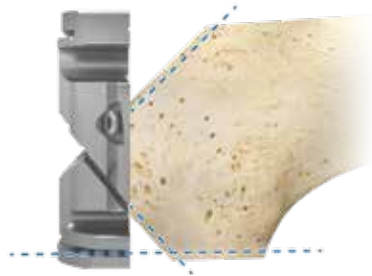

Figure 2



Figure 4

Odd Sized Persona Primary to Odd Sized Persona Revision Femoral Conversion

If an odd sized primary femur (sizes 1, 3, 5 etc.) was selected, the same size odd revision standard or plus size version can be used without additional cuts. Proceed to the Tapered Stem Preparation section on page 4.

If an even sized primary femur was initially selected, it will need to be converted to an odd size revision femur by removing additional posterior bone. The following sections instructs how to resect the appropriate amount of posterior bone based on whether the initial 4-in-1 bone cuts were performed via an anterior or posterior referencing technique.

Even Sized Persona Primary To Odd Sized Persona Revision Femoral Conversion

Anterior Referencing

Select the odd sized primary 4-in-1 cut block that is **one size smaller** than the even size previously trialed. For example, if the primary femoral provisional was a size 8, select the size 7 primary 4-in-1 cut block.

ⓘ **Note:** Size 12 primary and size 13 revision femoral components have the same anterior, posterior and chamfer cuts.

Place the odd sized primary 4-in-1 cut block in the same holes that were drilled for the original even sized primary 4-in-1 cut block and pin it to the femur (Figure 1). Make the posterior and chamfer cuts using a reciprocating or oscillating saw (Figure 2).

ⓘ **Note:** No bone should be resected anteriorly.

Remove the 4-in-1 cut block.

Proceed to the Tapered Stem Preparation section on page 4.

Posterior Referencing

Place the primary 4-in-1 cut block used to make the primary cuts back on the femur (Figure 3). Drill the **↑** 2 mm anterior shift holes through the primary 4-in-1 cut block (Figure 4). Remove the primary 4-in-1 cut block.



Figure 5

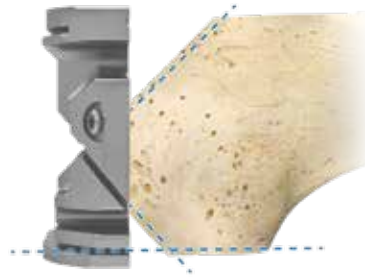

Figure 7

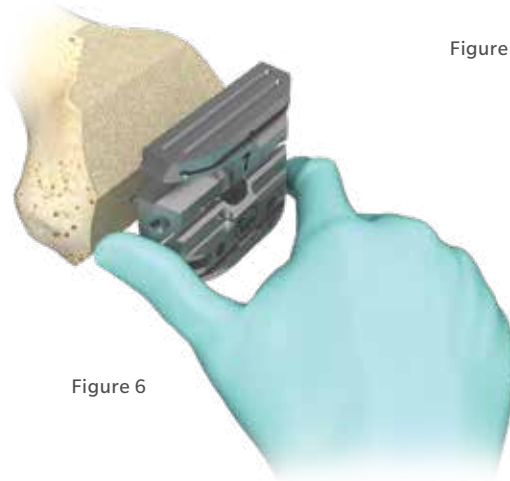

Figure 6

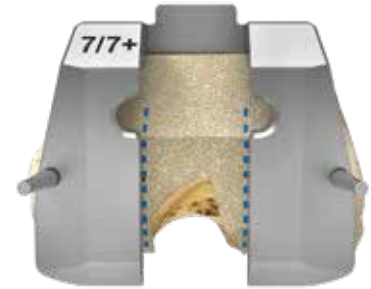

Figure 8

Posterior Referencing (cont.)

Select the odd sized primary 4-in-1 cut block that is **one size smaller** than the even size previously trialed. For example, if the primary femoral provisional was a size 8, select the size 7 primary 4-in-1 cut block.

Place the odd sized primary 4-in-1 cut block in the holes that were drilled for the **2 mm** anterior shift (Figures 5 and 6). Pin the cut block to the femur and make the posterior, anterior and posterior chamfer cuts using a reciprocating or oscillating saw (Figure 7).

Note: No bone should be resected anteriorly.

Remove the 4-in-1 cut block.

Tapered Stem Preparation

Place the revision notch cut guide on the femur that is the same size as the odd primary 4-in-1 cut guide used. Pin the revision notch cut guide to the femur with trochar pins (Figure 8).

Note: If desired, the odd size Persona Primary Femoral Provisional can be used to mark the inside edges of the femoral notch directly on the femur. Ensure the M/L alignment of the femoral provisional is adequate. The primary femoral provisional marks can be used to align the revision notch cut guide for the femoral box cut preparation.



Figure 9

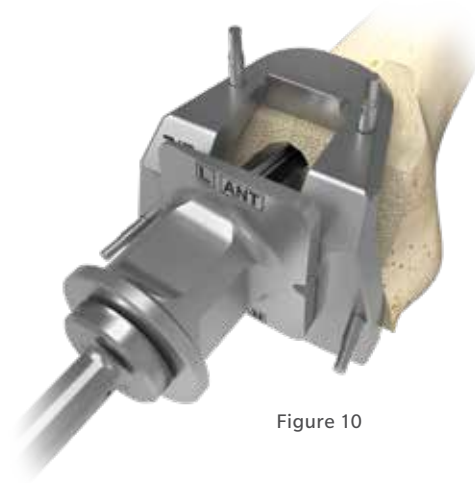

Figure 10



Figure 11

Tapered Stem Preparation (cont.)

ⓘ **Note:** The femoral box cut can be cut through the revision notch cut guide prior to drilling. Consider cutting the box first if unable to advance the drill into the bone. If necessary, proceed to the Optional Femoral Box Cut Preparation Using the Notch Cut Guide section on page 6.

Place the notch cut drill guide on the revision notch cut guide ensuring that the appropriate “Left” or “Right” identifier is anterior (Figure 9).

Drill for the 14 mm x 30 mm stem and femoral stem housing using the revision 14 mm x 30 mm drill bit. Start power prior to contact, and drill until the hard stop (Figure 10). Remove all components.

Femoral Provisional Assembly and Insertion

Attach the 14 mm x 30 mm stem provisional to the revision femoral provisional by inserting the 5 mm hex driver into the screw in the femoral provisional. Tighten in a clockwise direction (Figure 11).

ⓘ **Note:** 2 mm of posterior bone will be removed when downsizing from an even sized primary femoral provisional to an odd sized revision femoral provisional. The plus size femur may be utilized to make up for the additional 2 mm of bone removed from downsizing and adds 1 mm of additional flexion fill.



Figure 12

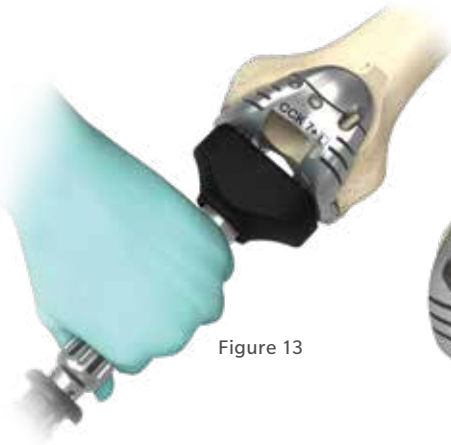

Figure 13



Figure 14



Figure 15

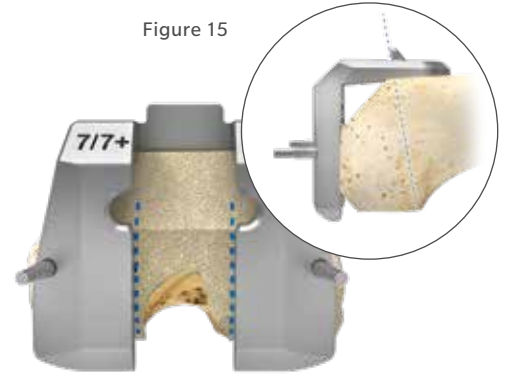

Figure 16

Femoral Box Cut Preparation

Insert the femoral provisional construct into the femur by hand. To fully seat, assemble the primary femoral impactor block to the primary quick connect handle and impact (Figures 12 and 13).

With the femoral provisional in place and the desired position set, resect along each interior edge of the femoral provisional with a reciprocating saw. Make the wall cuts first, then proceed with the proximal box cut along the ramp surface of the femoral provisional until the intercondylar bone is resected (Figure 14). Once the bone has been removed, insert the femoral box provisional that matches the same size and side as the femoral provisional until fully seated (Figure 15). Recut the femoral box if unable to insert the box provisional. It is likely that bone is obstructing assembly.

- ⓘ **Note:** Prior to making a femoral box cut, the knee must be in flexion to allow adequate visualization of the posterior capsule to avoid unintended neurovascular damage. Consider using the Persona Revision Femoral Retractor while in flexion to elevate the femur and protect the posterior structures while making the resection.
- ⓘ **Note:** The femoral box provisionals are size and side specific and are compatible with both the standard and plus femoral provisionals.

Optional Femoral Box Cut Preparation Using the Notch Cut Guide

Ensure the notch cut guide is pinned to the bone. Cut the femoral box by resecting along each interior edge of the notch cut guide with a reciprocating saw. Make wall cuts first, then proceed with the proximal box cut along the ramp surface of the notch cut guide until the intercondylar bone is removed (Figure 16).

When inserting the femoral provisional construct, ensure the box walls are aligned to the cuts made with the notch cut guide. If there is difficulty assembling the box provisional, the box cuts may need to be cleaned up through the femoral provisional.

- ⓘ **Note:** The outer M/L width of the notch cut guide represents the M/L width of the femoral implant.
- ⓘ **Note:** If the box was previously cut, the inner walls of the notch cut guide can be aligned to the previous box cut. Ensure M/L alignment is adequate.



Figure 17



Figure 18



Figure 19

Trial Reduction

The TASP construct is available in PS, CPS and CCK configurations.

Note: The Persona Primary TASP System is not compatible with the Persona Revision TASP System. The Persona Revision TASP PS, CPS and CCK TASPs are available in 2 mm increments. If 1 mm increments are required for PS TASP use, the Persona Primary TASP System (Tops, Silver Shims and Bottoms) must be utilized.

TASP Assembly

The TASP consists of three parts: the TASP bottom, top and shim. Select the TASP bottom that matches the tibial baseplate provisional. Select the TASP top that matches the same size tibial baseplate provisional and the femoral provisional.

The TASP top is marked to indicate constraint, compatible femurs and compatible tibias. In addition to the markings on the parts, the same colors are used for the mating TASP tops and bottoms. Align the post on the bottom with the pocket on the corresponding TASP top (Figure 17). Select the set of TASP shims that match the selected tibial provisional size.

There are three TASP bottom thicknesses. Reference the chart below for TASP bottom thicknesses and

TASP Bottom Thickness	Tibial Constructs
+0 mm	10-14 mm
+6 mm	16-20 mm
+12 mm	22-26 mm

Attach the tibial sizing plate handle to the appropriate shim (Figure 18). While holding the TASP top and bottom together with one hand, lock the TASP top and bottom together by inserting the appropriate shim with the tibial sizing plate handle (Figure 19). The shim will create a TASP construct which matches the thickness of the tibial bearing implant. See the example below to calculate bearing thickness.

Shim +	Bottom TASP	= Implant Bearing Thickness
12 mm	6 mm	18 mm



Figure 20



Figure 21



Figure 22

Trial Reduction (cont.)

It is recommended that the thinnest TASP construct (10 mm) be inserted into the joint space with the knee in greater than 30 degrees of flexion to perform an initial range of motion assessment (Figure 20). Apply gentle manual pressure while inserting without impacting the TASP construct with either a mallet or hand.

Note: The CPS and CCK TASP may be assessed if further stability is needed. The CPS and CCK bearing provide an increased level of constraint.

CPS and CCK Bearing TASP Assembly

The provisional lockdown screw should be used with the tibial provisional during range of motion assessment to give the CPS and CCK TASP constructs the necessary rigidity to assess varus/valgus and internal/external rotational constraint. The provisional lockdown screws are specific to the TASP bottom thickness being used. Reference the chart below for appropriate screw length use.

Shim Thickness (mm)	Bottom Thickness (mm)	Screw Length (mm)	Tibial Construct Thickness (mm)
10 12 14	+0	10-14	10-14
10 12 14	+6	16-20	16-20
10 12 14	+12	22-26	22-26

Use the 3.5 mm hex driver to lightly tighten until the head of the provisional lockdown screw has fully seated in the counterbore in the TASP top (Figures 21 and 22). Do not overtorque the provisional lockdown screw.

Note: The provisional lockdown screw is not compatible with the final tibial baseplate implant.



Figure 23

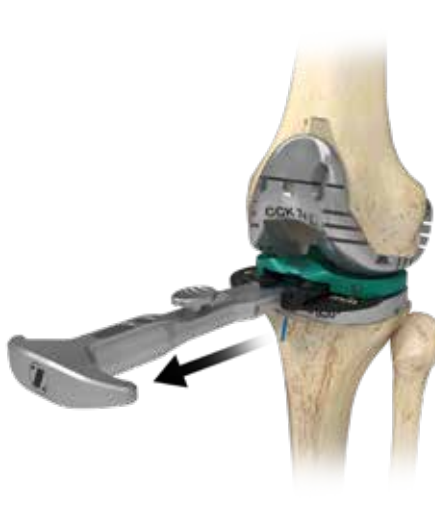

Figure 24



Figure 25

Trial Reduction (cont.)

TASP Shim Exchange

If a thicker construct is needed to appropriately fill and balance the joint space, place the knee in approximately 5–15 degrees of flexion to facilitate in-vivo removal and insertion of the shim with the tibial sizing plate handle (Figure 23).

ⓘ **Note:** The CPS and CCK TASP provisional lockdown screw must be loosened with the 3.5 mm hex driver to exchange the shim. It is not necessary to remove the provisional lockdown screw if the TASP bottom is not being exchanged.

Attach the tibial sizing plate handle to the shim and pull anteriorly to remove (Figure 24). Insert a new shim by aligning with the TASP top and bottom and push posteriorly. If significant resistance is experienced during insertion, realign and reinsert.

ⓘ **Note:** If using a CPS or CCK TASP, lightly tighten the provisional lockdown screw with the 3.5 mm hex driver until the head of the provisional lockdown screw has fully seated in the counterbore in the TASP top.

Check ligament stability in extension, in 30, 60 and 90 degree flexion with the patella reduced. Attempt to distract the joint in flexion. Flex the knee to peak flexion and verify that the spine still engages the cam.

TASP Removal

The entire TASP construct must be removed to exchange the bottoms in the TASP construct. If using a CPS or CCK TASP, disengage the provisional lockdown screw by rotating the 3.5 mm hex driver in a counterclockwise direction. Remove the provisional screw from the joint. To remove or exchange the bottom, flex the knee greater than 30 degrees, push in the TASP posteriorly to disengage anteriorly (1) and lift (2) the tibial sizing plate handle while attached to the TASP construct (Figure 25). Once the anterior lip of the TASP bottom is above the anterior rail of the tibial baseplate provisional, rotate the TASP out of the joint space medially or laterally, if possible. This will aid in preventing unwanted shim disassembly during TASP removal.

ⓘ **Note:** Varus/valgus forces may make it difficult to remove the TASP construct. To aid in the removal of the TASP and prevent breakage, ensure that the joint is in a neutral position when removing the TASP construct.

ⓘ **Note:** Use only the tibial sizing plate handle to remove the TASP construct. The use of other instruments may damage or break the TASP.

ⓘ **Note:** Do not implant the TASP components.

Flexion and Extension Decision Matrix

	Tight in Extension	Stable in Extension	Loose in Extension
Tight in Flexion	Decrease tibial bearing thickness	Downsize femur	Use distal femoral augments* and thinner tibial bearing
	Resect more tibia	Use distal femoral augments* and thinner tibial bearing Offset the femur anteriorly and use thinner tibial bearing*	Downsize the femur and use thicker tibial bearing Offset the femur anteriorly and use thicker tibial bearing*
Stable in Flexion	Resect additional distal femur	Gaps balanced	Use distal femoral augments* Downsize femur and use thicker tibial bearing
Loose in Flexion	Resect distal femur and use Plus size femur	Use a plus size femur	Increase tibial bearing thickness
	Resect distal femur and use thicker tibial bearing		Add/increase tibial augments* Use distal femoral augments* and Plus size femur

* If offset stems or augments are required, reference the Persona Revision Surgical Technique

Trial Reduction (cont.)

Flexion and Extension Gap Analysis

With all provisional components in place, check ligament stability in extension, in 30, 60, 90 and 120 degrees of flexion with the patella reduced and check for posterior osteophytes. Attempt to distract the joint in flexion. Reference the Flexion and Extension Decision Matrix to help recreate a stable joint. Perform a range of motion to check component positioning and joint stability (Figure 26).

Patella Resurfacing

If resurfacing the patella, reference the Persona Primary Surgical Technique 97-5026-001- 00.

Final Trialing

With the final provisional components in place, reinsert the TASP assembly into the joint. Check ligament stability in extension, in 30, 60, 90 and 120 degrees of flexion. Attempt to distract the joint in flexion. Perform a range of motion to check patellar tracking. Ensure the spine clears all bone in the femoral box.



Figure 26

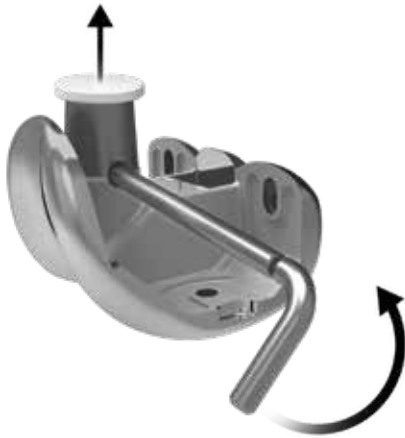

Figure 27



Figure 28



Figure 29

Implant Assembly

Tibial Implant Assembly

To assemble the tibial baseplate implant, reference the Persona Primary 14 mm x +30 mm Stem Extension Surgical Technique 97-5026-037-00.

Femoral Implant Assembly

It is highly recommended that new gloves be applied prior to handling the femoral implants.

Place the femoral implant on a rigid table protected by a soft surface. Use the 2 mm hex driver to loosen the set screw to remove the taper cap from the femoral implant. Ensure the set screw in the stem housing is backed out in order for the stem to seat fully (Figure 27). Place the stem in the femur (Figure 28). While protecting the tip of the stem with a soft cloth, firmly impact the stem to engage the tapers. Tighten the set screw with the 2 mm hex driver in a clockwise direction (Figure 29).

ⓘ **Note:** The 2 mm hex driver has an over-torque limiter built into the design of the handle so it will break to prevent over-torquing.

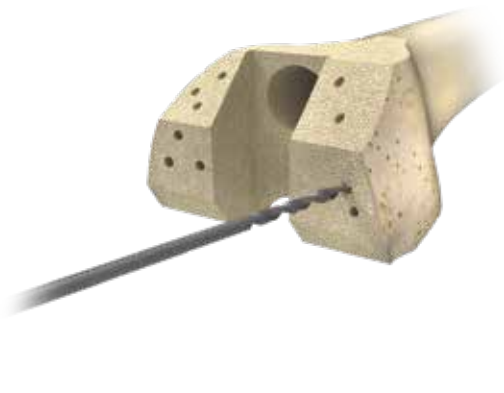

Figure 30



Figure 31



Figure 32

Two Stage Cementing Technique

Tibial Cementing Technique

To cement the tibial baseplate implant, reference the Persona Primary 14 mm x +30 mm Stem Extension Surgical Technique 97-5026-037-00.

Femoral Cementing Technique

Prior to applying cement, use allograft or substitute to plug femoral lug holes if drilled for the primary femur. A bone plug or bone chips should be used to plug the femoral canal. If the femoral bone is dense or sclerotic, it may be necessary to perforate the femur by drilling with the 3.2 mm drill 3–4 mm deep, spaced 5 to 8 mm apart to improve cement penetration (Figure 30).

Cleanse all cement-receiving bone surfaces thoroughly using pulse lavage and dry with a clean, dry lap sponge (Figure 31). Next, mix a single 40g unit of cement. Additional cement may be necessary due to the size of the femur and components being utilized. Use of a vacuum mixing cartridge is recommended as well as application of new gloves.

As soon as cement properties permit, apply a thick layer of cement over the entire underside of the femoral implant including the stem/femoral housing junction and the stem transition (Figure 32). The 14 mm x +30 mm stem is intended for full cemented use. Avoid contamination of the component-cement interface.



Figure 33



Figure 35



Figure 34

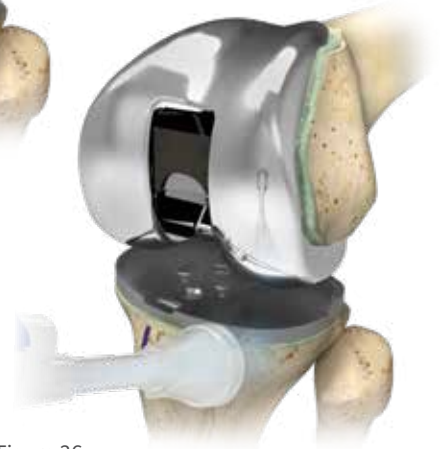

Figure 36

Femoral Cementing Technique (cont.)

Apply cement on the surface of the distal femur and pressurize prior to inserting the femoral construct, striving for penetration of 3–4 mm (Figure 33).

ⓘ **Note:** Use of a cement gun/cartridge equipped with a pressurizing nozzle is recommended.

With the knee in deep flexion, insert the femoral component into the femoral canal by hand, while retrograde filling the canal with cement. Once inserted by hand, seat the femoral component using the primary quick connect handle and femoral impactor pad (Figure 34). Remove any excess cement in a routine manner (Figures 35 and 36). Check for excess cement above and in the femoral box to ensure adequate clearance of the articular surface spine.

ⓘ **Note:** Any cement will prevent the proper assembly of the TASP and final bearing assembly.

If cementing the patella, reference the Persona Primary Surgical Technique 97-5026-001-00 for cement steps.

The knee should be placed in extension for the cement to cure. A TASP can be used to assist with compression on the cement. Insert a TASP 2 mm thicker than the final bearing in order to increase the pressure on the cement. If the knee cannot be straightened out at the time of cementing the femur, constant pressure should be exerted in order to obtain the best possible compression on the cement.

Once the cement has cured, remove any excess cement before final bearing assembly. Confirm that all cement has been removed from the proximal surface of the tibial baseplate implant especially posterior near the locking mechanism.

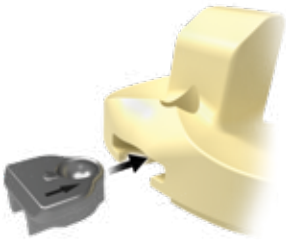

Figure 37



Figure 38



Figure 39

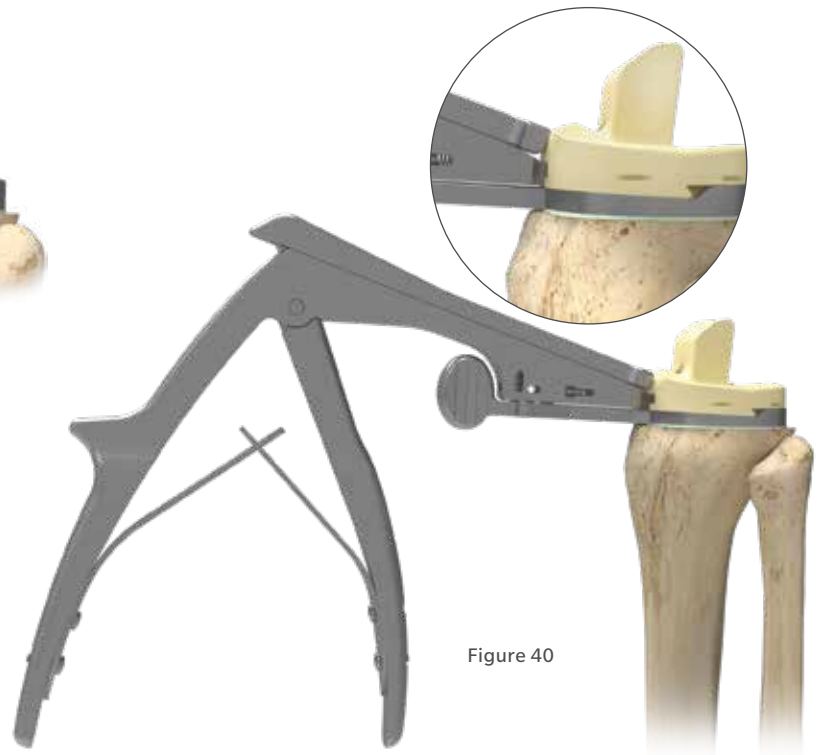

Figure 40

Bearing Assembly and Insertion

The TASP construct can be used to check for final range of motion with the tibial and femoral components. Ensure the cement is fully cured.

ⓘ **Note:** The TASP construct cannot be locked down to the final implants.

CCK Bearing Insert Assembly

Begin by pressing the insert packaged with the bearing into the slot on the CCK bearing (Figure 37). Once the insert has been assembled, set the CCK bearing on the tibial baseplate.

ⓘ **Note:** To avoid post impingement with the femoral component, place the knee in mid-flexion prior to inserting the bearing.

PS, CPS and CCK Bearing Assembly

ⓘ **Note:** The articular surface inserter applies both downward and rearward forces to aid in the insertion of the bearing onto the tibial baseplate.

Choose the correct tibial bearing based on femoral size, tibial size, side, constraint and thickness as determined during trial range of motion.

Prior to assembly, ensure soft tissue and cement debris are removed from the locking mechanism. Place the bearing onto the tibial baseplate. Apply finger pressure anterior to posterior to properly engage the tibial baseplate and bearing. This is necessary to allow the inserter to properly engage the tibial baseplate and bearing for final seating (Figure 38). Steady the surface of the tibial baseplate with one hand by applying downward pressure near the posterior cruciate cutout.

ⓘ **Note:** Insert a bearing only once. Never reinsert the same bearing onto a tibial baseplate.

Engage the hook on the articular surface inserter with the mating slot on the front of the tibial baseplate and close the lever with your index finger. This locks the inserter to the tibial baseplate (Figure 39). Squeeze the handle of the articular surface inserter to seat the bearing (Figure 40). Open the lever and remove from the bearing.

ⓘ **Note:** Do NOT impact or lever the articular surface inserter when attached to the tibial baseplate. This may disrupt the fixation of the tibial baseplate to the bone and/or cause damage to the implant or instrument. Do not impact the bearing.



Figure 41



Figure 42

CCK Bearing Lockdown Screw Assembly

Insert the screw packaged with the bearing through the hole in the bearing and into the tibial baseplate (Figure 41). Hand tighten the screw using the 4.5 mm hex driver (Figure 42). Attach the counter torque wrench to the anterior slot of the tibial baseplate and tighten the knob.

While holding the counter torque wrench, use the deflection beam torque wrench to tighten the screw to 95 in-lbs (Figure 43). Reduce the joint and move the knee through flexion and extension. It is recommended that the torque wrench is tightened two times to the targeted 95 in-lbs.

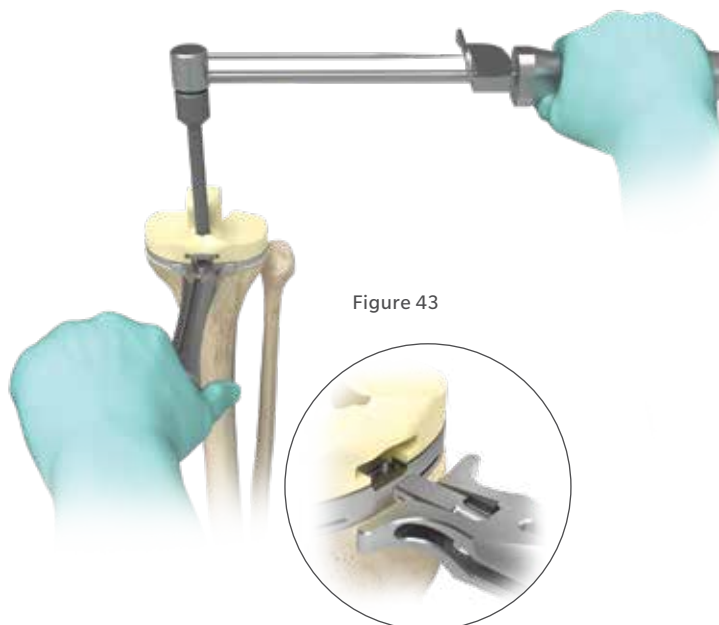

Figure 43

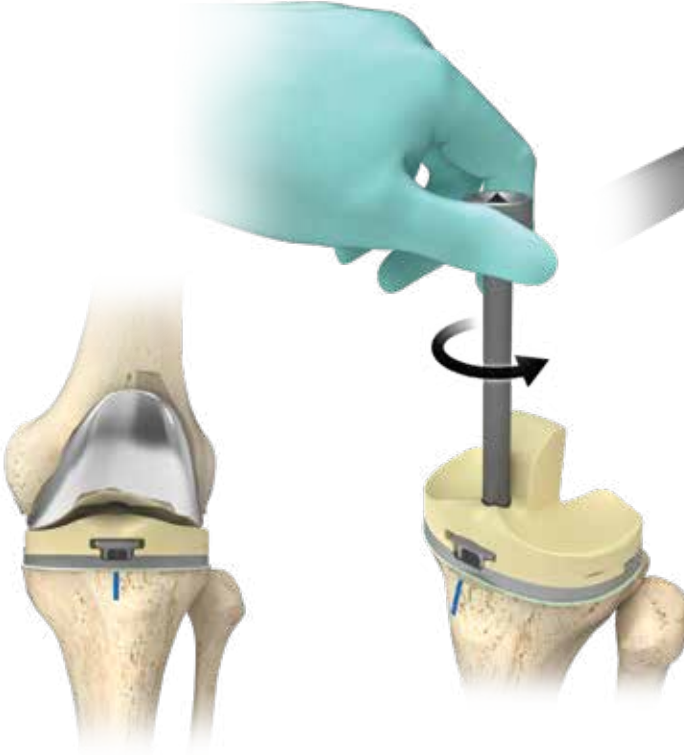

Figure 44

Figure 45

Close Incision

Freely irrigate the wound to ensure unwanted debris is removed from the joint space prior to closure. Implant assembly is now complete (Figure 44). A drain may be placed intracapsularly. Close the wound with sutures and apply a bandage.

ⓘ **Note:** Take care that the retractors do not inadvertently dislodge the tibial baseplate, particularly on the posterolateral corner. Verify that the femoral component is fully seated before closing the wound. Confirm that no portion of the quadriceps mechanism have been pinned beneath the femoral component before closing the wound.



Figure 46



Figure 47

Component Removal

PS, CPS and CCK Bearing Removal

In the event that the bearing needs to be removed from the tibial baseplate, begin by removing the screw, if equipped (Figure 45). Next, engage the hook on the bearing extractor instrument with the mating slot on the front of the tibial baseplate and squeeze the handle to disengage the bearing from the tibial baseplate implant (Figure 46).

ⓘ **Note:** The bearing extractor instrument should not be used for provisional removal.

Tibial Baseplate Component Removal

In the event that the tibial baseplate needs to be removed, disrupt the bone cement interface using an osteotome.

Femoral Component Removal

Disrupt the femoral implant/bone interface with flexible osteotomes or thin saw blades with an oscillating saw. Once the prosthetic bone interface is loosened, a femoral extraction tool may be used to aid in removal of the femoral component from the bone. Persona Revision Femurs have medial and lateral notches to help facilitate removal of the femoral component (Figure 47).

Product Compatibility Charts

Persona Revision Femoral Component Used on Persona Revision CCK, Persona CPS or Persona PS Articular Surface

		Persona Revision Femoral Components													
		1	1+	3	3+	5	5+	7	7+	9	9+	11	11+	13	
A	1-1+/AB	3-5+/AB													
B		3-5+/AB													
C	1-1+/CD	3-5+/CD					7-9+/CD								
D		3-5+/CD					7-9+/CD								
E		3-5+/EF					7-9+/EF					11-11+/EF			
F		3-5+/EF					7-9+/EF					11-11+/EF			
G							7-9+/GH					11-13/GH			
H							7-9+/GH					11-13/GH			
J												11-13/J			

Note: Ultra Congruent (UC), Cruciate Retaining (CR) and Medial Congruent® (MC) bearings are not compatible with Persona Revision Femoral Components.

Persona Revision Femoral Component Used with Persona Patellae

		Persona Revision Femoral Component												
		1	1+	3	3+	5	5+	7	7+	9	9+	11	11+	13
Persona All-Poly (UHMWPE) Patellar Component (42-5400-000-XX) and Vivacit-E® Patellar Component (42-5402-000-XX) (mm sizes)	26	i	i	i	i	i	i	i	i	i	i	i	i	i
	29											i	i	i
	32											i	i	i
	35													
	38													
	41													

i: INSET patella with Persona Revision Femoral Component

Compatible
 Incompatible

Product Compatibility Charts (cont.)

Persona Revision Femoral Component Used with NexGen® Patellae

		Persona Revision Femoral Component												
		1	1+	3	3+	5	5+	7	7+	9	9+	11	11+	13
NexGen All-Poly Patellar Component (00-5972-065-XX) and Prolong® Patellar Component (00-5972-066-XX) (mm sizes)	26	i	i	i	i	i	i	i	i	i	i	i	i	i
	29											i	i	i
	32											i	i	i
	35													
	38													
	41													

i: INSET patella with Persona Revision Femoral Component

Compatible
 Incompatible

		Persona Revision Femoral Component												
		1	1+	3	3+	5	5+	7	7+	9	9+	11	11+	13
NexGen Primary Porous Patellar Component (00-5878-065-XX) (mm sizes)	32											i	i	i
	35													
	38													
	41													

i: INSET patella with Persona Revision Femoral Component

Compatible
 Incompatible

Zimmer Biomet does not practice medicine. This technique was developed in conjunction with health care professionals. This document is intended for surgeons and is not intended for laypersons. Each surgeon should exercise his or her own independent judgment in the diagnosis and treatment of an individual patient, and this information does not purport to replace the comprehensive training surgeons have received. As with all surgical procedures, the technique used in each case will depend on the surgeon's medical judgment as the best treatment for each patient. Results will vary based on health, weight, activity and other variables. Not all patients are candidates for this product and/or procedure. Caution: Federal (USA) law restricts this device to sale by or on the order of a surgeon.

All content herein is protected by copyright, trademarks and other intellectual property rights, as applicable, owned by or licensed to Zimmer Biomet or its affiliates unless otherwise indicated, and must not be redistributed, duplicated or disclosed, in whole or in part, without the express written consent of Zimmer Biomet.

This material is intended for healthcare professionals. Distribution to any other recipient is prohibited.

For indications, contraindications, warnings, precautions, potential adverse effects and patient counseling information, see the package insert or contact your local representative; visit www.zimmerbiomet.com for additional product information.

Not for distribution in France.

Check for country product clearances and reference product specific instructions for use.

© 2019 Zimmer Biomet



1526.1-GLBL-en-REV0619 MC215260



Authorized Representative

Zimmer GmbH
Sulzerallee 8
8404 Winterthur
Switzerland

Zimmer U.K. Ltd.
The Courtyard
9 Lancaster Place
South Marston Park
Swindon, Wiltshire SN3 4FP
United Kingdom



Legal Manufacturer

Zimmer, Inc.
1800 West Center Street
Warsaw, Indiana 46580
USA

zimmerbiomet.com

CE 2797

CE 0086

CE mark on a surgical technique is not valid unless there is a CE mark on the product label.