

# Trabecular Metal™ Tibial and Femoral Cones

Surgical Technique



ZIMMER BIOMET  
Your progress. Our promise.®



# Table of Contents

<b>Section 1: Medium Tibial Cones</b> .....	2
Introduction .....	2
Assessment of the Tibial Bone .....	4
Preparing for the Tibial Implant .....	7
Preparing for the Medium Tibial Cone - Initial Reamer .....	12
Provisional Assembly and Assessment .....	17
Final Positioning of the Cone and Tibia .....	18
Implantation Technique - Cemented .....	20
Removal Instructions .....	21
<b>Section 2: Large Tibial Cones</b> .....	22
Introduction .....	22
Tibial Preparation .....	24
Cone Size Evaluation .....	25
Preparing the Bone .....	30
Final Positioning of Cone in the Tibia .....	34
Implantation Technique - Cemented .....	36
Removal Instructions .....	37
<b>Section 3: Diaphyseal Femoral Cones</b> .....	38
Introduction .....	38
Distal Femur Preparation .....	40
Broach to the Appropriate Cone Size .....	42
Provisional Stem Extension Selection .....	45
Trial positioning of the Assembly .....	45
Filling Gaps Outside of the Cone .....	46
Final Trialing .....	46
Implantation Technique - Cementless .....	47
Removal Instructions .....	51
<b>Section 4: Metaphyseal Femoral Cones</b> .....	52
Introduction .....	52
Distal Femur Preparation .....	54
Stem Extension Provisional Selection .....	54
Femoral Cone Size Selection .....	56
Metaphyseal Femoral Cones .....	57
Final Trialing .....	58
Implantation Technique - Cementless .....	58
Removal Instructions .....	61

## Section 1: Medium Tibial Cones

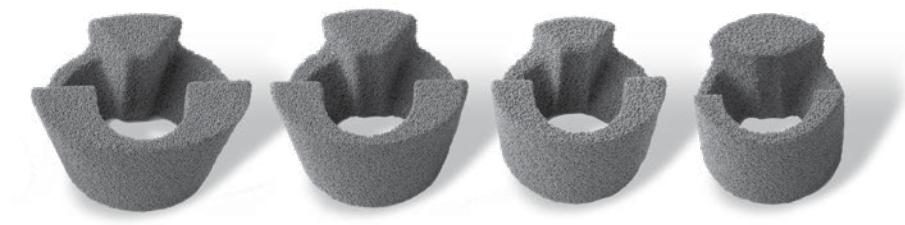

Figure 1

### Introduction

The objective of using the Trabecular Metal Medium Tibial Cone Implant is to achieve stability of the construct within the proximal tibia when small to medium bone voids are present. The cone that is selected must offer the ability to:

- Reinforce the medullary cavity of the tibia
- Fill a proximal tibia bone void that may result from the removal of a primary knee system
- Allow the entire assembled and seated construct (cone and tibial base plate/stem extension) to provide appropriate support of the tibial baseplate

### US and Outside the United States (excluding EU) indications

The Trabecular Metal Medium Tibial Cones are intended for use where severe degeneration, trauma, or other pathology of the knee joint indicates total knee arthroplasty. When used with the NexGen Complete Knee Solution – Rotating Hinge Knee (RHK) System, the Trabecular Metal Medium Tibial Cones are for cemented use only. When used with the NexGen Complete Knee Solution – Legacy Constrained Condylar Knee System, the Trabecular Metal Medium Tibial Cones are for cementless or cemented use.

### EU Indications

The Trabecular Metal Medium Tibial Cones are intended for use where severe degeneration, trauma, or other pathology of the knee joint indicates total knee arthroplasty. These are not intended for primary cases.

The Trabecular Metal Medium Tibial Cones are intended to be used for cementless fixation to host bone with NexGen Complete Knee Solution – Rotating Hinge Knee (RHK) and NexGen Complete Knee Solution – Legacy Constrained Condylar Knee System (LCCK). The use of cement is intended for fixation to RHK components for assembly.

## Section 1: Medium Tibial Cones



Figure 2

### Introduction (cont.)

In revision situations, positioning of the tibial baseplate is often dictated by the interaction of the tibial baseplate is often dictated by the interaction of the stem extension (attached to the baseplate). and the intramedullary canal. Therefore, use of offset and/or straight stem extensions should be considered during the initial cone selection process (Figure 2).

**Note:** Offset stems cannot be used with the NexGen RH.

The Trabecular Metal Medium Tibial Cone System features instruments which reference the IM canal. This alignment feature ensures that the position of the cone does not interfere with the final position of the tibial baseplate/stem extension construct. Furthermore, the instruments help to remove bone only to the depth that matches the cone implant and to cut at a trajectory that matches the shape of the implant.

## Section 1: Medium Tibial Cones Surgical Steps

### Assessment of the Tibial Bone

Remove existing tibial implants as well as residual granuloma/fibrous tissue as necessary to ensure proper exposure of the bone.

🔊 **Technique Tip:** Ensure that all cement is removed from the intramedullary canal, as retained cement may result in fracture or deflection of the reamer.

Prepare the tibial canal by using progressively larger intramedullary reamers beginning with the 9 mm diameter reamer. Ream to a depth that allows all the reamer teeth to be buried beneath the surface of the bone for the stem length that is desired. Proceed to ream up to the diameter size that rigidly engages the endosteal cortex of the isthmus.

Cut the top of the tibia to the angle recommended for the tibial baseplate using the appropriate IM tibial boom and appropriate tibial cutting guide. The technique for this step in the procedure is illustrated in the NexGen LCKK and RH Knee Surgical Techniques.

## Section 1: Medium Tibial Cones Surgical Steps



Figure 3



Figure 4

### Assessment of the Tibial Bone (cont.)

It is critical that this step be performed using intramedullary alignment to ensure proper alignment between the medium tibial cone and the stem of the tibial component.

Examine the tibial defect that is present by placing the medium tibial cone provisionals upside down on the tibial plateau over the reamer in order to assess the size and orientation of the bony defect. Note the size of the medium tibial cone provisional that will adequately cover the defect (Figure 3).

**Note:** If the defect exceeds 46 mm medial/lateral (the size of the largest Trabecular Metal Medium Tibial Cone), consider using Trabecular Metal Large Tibial Cones.

Remove the reamer and insert the provisional stem that matches the diameter and depth the last reamer prepared with the cone alignment rod attached. The provisional stem must be stable within the IM canal (Figure 4).

Medium Tibial Cone Provisional  
00-5451-013-31



Straight Stem Extension  
Provisional  
00-5989-010-10



Cone Alignment Rod  
00-5452-013-20



## Section 1: Medium Tibial Cones



Figure 5

### Assessment of the Tibial Bone

(cont.)

Place medium tibial cone sizing templates on the tibial plateau over the cone alignment rod to determine the correct size and orientation of the tibial tray (Figure 5). The position of the cone alignment rod within the sizing template will indicate whether or not an offset stem will be necessary.

ⓘ **Note:** Check the chart on page 13 to ensure that the desired tibial component size is compatible with the selected cone size.

ⓘ **Note:** The offset stem option can only be used with the NexGen LCCK Knee. The RH Knee will require the use of a straight stem with the Trabecular Metal Medium Tibial Cone.

ⓘ **Technique Tip:** Stems are available in straight or 4.5 mm offset options. When determining which stem design is necessary, remember that the offset stem will move the center of the tibial baseplate exactly 4.5 mm away from the center of the IM canal.





## Section 1: Medium Tibial Cones



Figure 6



Figure 7

### Preparing for the Tibial Implant

**Note:** Two bushing guides, drill guides, and reamer guides are provided in the medium tibial cone instrument set. Each is marked as 7° or 0°. The 7° instruments are used when implanting the 7° NexGen tibial baseplate. The 0° instruments are used when implanting the NexGen A/P Wedge or RH Knee Tibial Baseplates.

#### If a Straight Stem is to be Used

**Note:** If using an offset stem, skip to the offset technique on page 9.

Fit the appropriate medium cone bushing guide over the cone alignment rod onto the medium tibial cone sizing template (Figure 6). Place the straight bushing from the NexGen LCCK or RH Knee Instrument Sets over the cone alignment rod and seat it in the bushing guide to ensure proper alignment between the baseplate and the IM canal (Figure 7).

**Technique Tip:** Ensure that proper rotation takes precedence over coverage of the tibial plateau.

Medium Tibial Cone Tibial Tray  
Offset Bushing Guide  
00-5452-013-25



Straight Building  
00-5987-003-10



Short-Head Holding Pins  
00-5977-056-01



## Section 1: Medium Tibial Cones

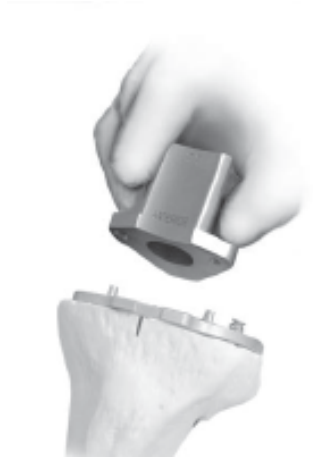

Figure 8

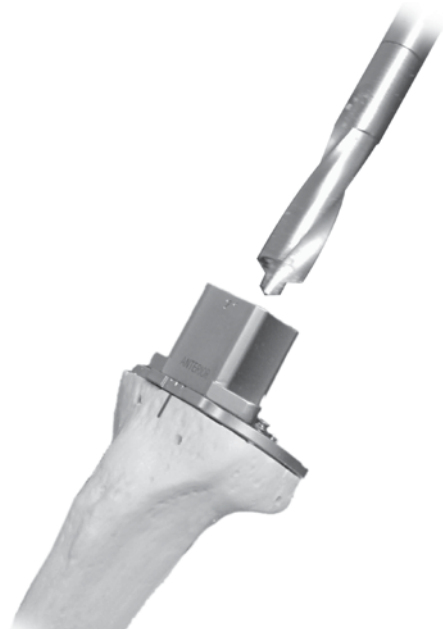

Figure 9

### Preparing for the Tibial Implant (cont.)

Pin the selected size medium tibial cone sizing template in its desired orientation using short headed pins from the NexGen LCKK or RH Knee Instrument Sets.

With the sizing template pinned in its desired position, mark the tibial bone with a bovie or methylene blue to identify the center of the anterior aspect of the tibial baseplate. This will be important when determining the rotational freedom of the cones when broaching.

Remove the provisional stem, cone alignment rod, bushing guide, and bushing leaving the medium tibial cone sizing template pinned in place.

Fit the medium cone tibial tray drill guide onto the medium tibial cone sizing template and use the tibial stem drill from the NexGen LCKK or RH Knee Instrument Sets to drill for the stem of the tibial component (Figure 8).

Drill until the engraved line on the tibial stem drill is approximately 10 mm past the top of the medium tibial cone tibial tray drill guide to prepare for the tibial stem and the junction of the stem extension (Figure 9).

Remove the tibial tray drill guide and stem drill leaving the medium tibial cone sizing template pinned in place.

**Note:** Proceed to Preparing for the Medium Tibial Cone – Initial Reamer (Page 12).

Medium Tibial Cone Tibial Tray  
Stem Drill Guide  
00-5452-013-21



Tibial Stem Drill  
00-5977-010-01



## Section 1: Medium Tibial Cones



Figure 10



Figure 11

### Preparing for the Tibial Implant (cont.)

#### If an Offset Stem is to be Used

Fit the medium cone bushing guide over the cone alignment rod and onto the medium tibial cone sizing template. Place the offset bushing from the NexGen LCCK Instrument Set over the cone alignment rod and seat it in the bushing guide. Rotate the bushing and the medium tibial cone sizing template to find the optimal position on the tibial plateau (Figure 10).

- ⊖ Technique Tip:** If the proper rotation cannot be achieved without overhang, choose the next smaller size tibial template. Be cognizant of size compatibility with the femur (detailed in the NexGen LCCK Surgical Technique). when choosing the size of the tibia.

When optimal coverage and orientation is achieved, note the position of the etched marks on the offset bushing relative to the etched mark on the center of the anterior portion of the medium tibial cone sizing template. Be aware that the visible portion of the offset bushing will have reference numbers that read upside down (Figure 11).

Medium Tibial Cone Tibial Tray  
Offset Bushing Guide  
00-5452-013-25



Offset Bushing  
00-5987-004-10



Short-Head Holding Pins  
00-5977-056-00



## Section 1: Medium Tibial Cones



Figure 12



Figure 13

### Preparing for the Tibial Implant (cont.)

This number is 180 degrees opposed to the number that should be referenced on the offset bushing. As a result, it is critical that the number used for reference on the bushing is the number that is facing right side up which is not visible when the bushing is seated in the offset bushing guide. It can be helpful to pull the bushing up out of its seated position so that the right side up number is visible when noting the final desired offset position (Figure 12).

Remove the tibial cone bushing guide, offset bushing, and stem extension provisional assembly leaving only the medium tibial cone sizing tibial template pinned in place.

Fit the medium cone tibial tray drill guide onto the medium tibial cone sizing template and use the tibial stem drill from the NexGen LCCK or RH knee instrument sets to drill for the stem of the tibial component (Figure 13).

Medium Tibial Cone Tibial Tray  
Stem Drill Guide  
00-5452-013-21



Tibial Stem Drill  
00-5977-010-01



## Section 1: Medium Tibial Cones

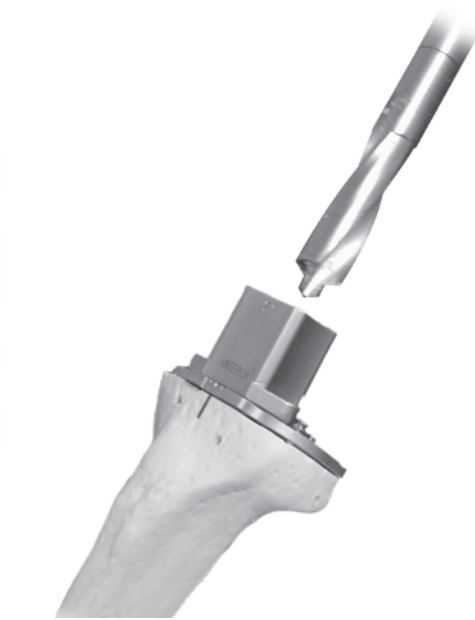

Figure 14

### Preparing for the Tibial Implant (cont.)

Drill until the engraved line on the stem drill is approximately 10 mm past the top of the medium cone tibial tray drill guide (Figure 14).

Remove the tibial cone drill and tibial cone drill guide leaving the medium tibial cone sizing template pinned in place. Assemble the appropriate size offset provisional stem to the cone alignment rod and insert the construct into the tibia to its desired depth and orientation.

Check to ensure that the cone alignment rod sits in the center of the medium tibial cone sizing template. This can be accomplished by fitting the tibial cone bushing guide over the cone alignment rod into the medium tibial cone sizing template. Slide the straight bushing from the NexGen LCKK instrument set over the cone alignment rod and seat it in the bushing guide. If the stem is aligned properly, the straight bushing will fully seat into the bushing guide.

Remove the bushing guide, straight bushing and cone alignment rod/stem provisional construct from the tibia, leaving the medium tibial cone sizing template pinned in place.

## Section 1: Medium Tibial Cones



Figure 15

### Preparing for the Medium Tibial Cone – Initial Reamer

Fit the tibial cone drill bushing onto the medium tibial cone sizing template (Figure 15).

Using the chart below, notice the drill depth required that matches the expected medium tibial cone size and tibial base plate size and note the depth number (1, 2, or 3). that is necessary for the sizes selected and identify these rings on the tibial cone reamer (Figure 16).



## Section 1: Medium Tibial Cones

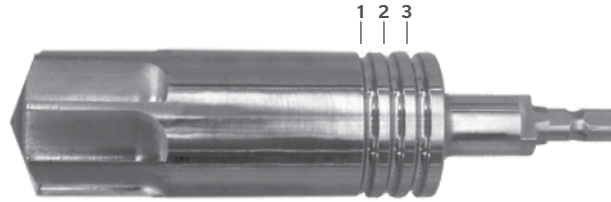

Figure 16

### Size Interchangeability and Reamer Depth Chart

Tibial Base Plate Size	Tibial Cone Size (mm)/Depth #			
	31 x 31 / 3	36 x 31 / 2	41 x 34 / 2	46 x 34 / 1
LCCK Size 3	31 x 31 / 3	36 x 31 / 2	41 x 34 / 2	46 x 34 / 1
LCCK Size 4	31 x 31 / 3	36 x 31 / 2	41 x 34 / 2	46 x 34 / 1
LCCK Size 5	N/A	36 x 31 / 2	41 x 34 / 2	46 x 34 / 1
LCCK Size 6	N/A	36 x 31 / 2	41 x 34 / 2	46 x 34 / 1
LCCK Size 7	N/A	N/A	N/A	46 x 34 / 1
RH Knee Size 2	31 x 31 / 3	36 x 31 / 2	41 x 34 / 2	46 x 34 / 1
RH Knee Size 3	31 x 31 / 3	36 x 31 / 2	41 x 34 / 2	46 x 34 / 1
RH Knee Size 4	31 x 31 / 3	36 x 31 / 2	41 x 34 / 2	46 x 34 / 1
RH Knee Size 5	31 x 31 / 3	36 x 31 / 2	41 x 34 / 2	46 x 34 / 1
RH Knee Size 6	31 x 31 / 3	36 x 31 / 2	41 x 34 / 2	46 x 34 / 1

### Preparing for the Medium Tibial Cone – Initial Reamer (cont.)

Using the chart below, notice the drill depth required that matches the expected medium tibial cone size and tibial base plate size and note the depth number (1, 2, or 3), that is necessary for the sizes selected and identify these rings on the tibial cone reamer (Figure 16).



## Section 1: Medium Tibial Cones

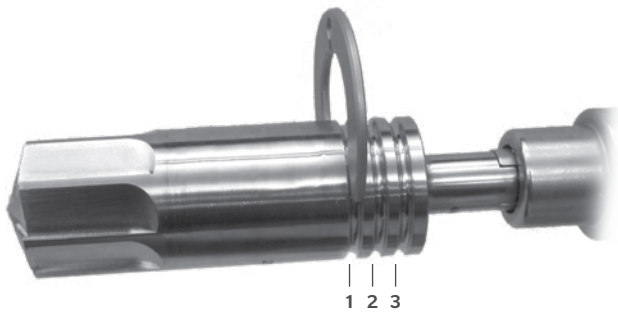

Figure 17

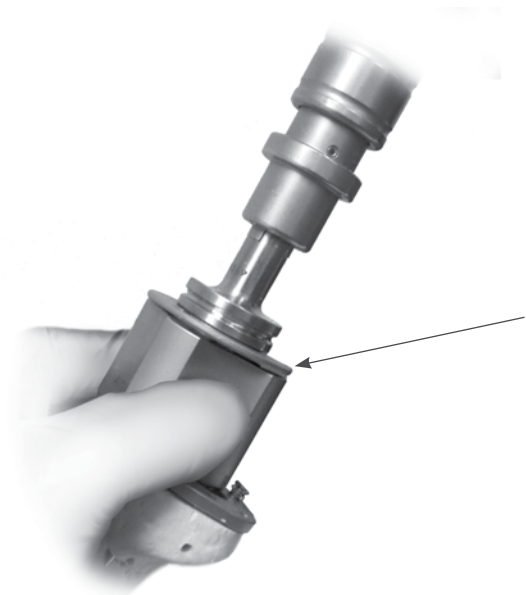

Figure 18

### Preparing for the Medium Tibial Cone – Initial Reamer (cont.)

Attach the reamer stop to the appropriate groove on the reamer (Figure 17). Using the tibial cone reamer, ream until the reamer stop meets the tibial cone reamer bushing (Figure 18).

☹ **Technique Tip:** Stabilize the tibial cone reamer bushing with your off hand while drilling to eliminate toggle, and to ensure that the drill is being used at the proper angle.

Remove the medium tibial cone sizing template and all other instruments from the tibia.





## Section 1: Medium Tibial Cones



Figure 19

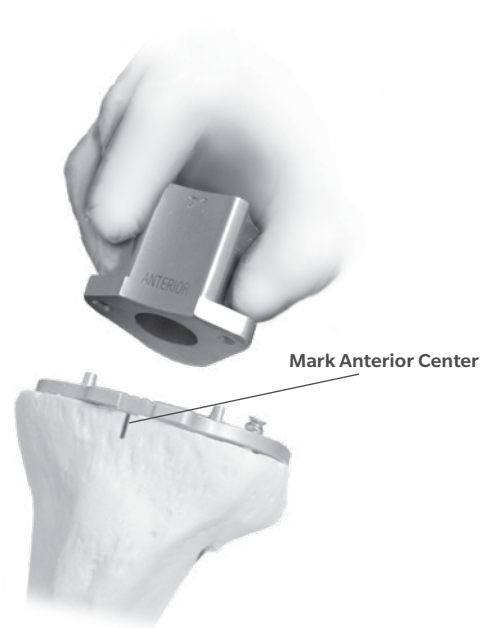

Figure 20

### Preparing for the Medium Tibial Cone – Initial Reamer (cont.)

Re-insert the selected provisional stem (straight or offset) with the cone alignment rod attached into the intramedullary canal to the correct depth and orientation.

**ⓘ Technique Tip:** Regardless of whether a cemented or cementless stem will be used, ensure that this provisional stem is stable in the IM canal for the next steps. If it is loose, sequentially upsize to a provisional stem size that provides stability.

Align the smallest medium tibial cone broach (31 x 31 mm) over the cone alignment rod (Figure 19). Make note of the mark on the tibia from the steps described in the preparing for the tibial implant section. The mark on the tibia should remain within the outer markings on the medium tibial cone broach to ensure that the rotational limit between the keel of the tibial component and tibial cone is not exceeded (Figure 20).



## Section 1: Medium Tibial Cones

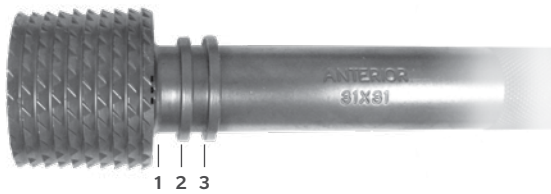

Figure 21



Figure 22

### Preparing for the Medium Tibial Cone – Initial Reamer (cont.)

After the described alignment checks have been performed, use a mallet to impact the broach to prepare the bone for the shape of the medium tibial cone implant. Use the rings on the broach to reference depth 1, 2, or 3 (Figure 21). Broach until the selected ring is level with the tibial plateau.

Sequentially broach over the cone alignment rod using the next largest size until the appropriate medium tibial cone size is reached. Take care to properly orient each broach to ensure that the rotational limits relative to the keel of the tibial baseplate is not exceeded and that the rotational alignment of each subsequent broach matches the rotation of the previous broach (Figure 22).

When sequential broaching is complete, remove the provisional stem, broach and cone alignment rod.



## Section 1: Medium Tibial Cones

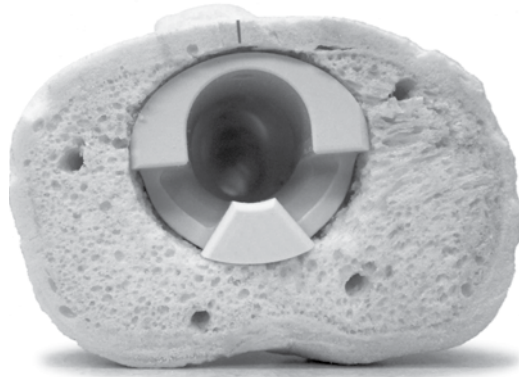

Figure 23

### Provisional Assembly and Assessment

ⓘ **Note:** In many cases, the medium tibial cone implant will not sit flush against the distal surface of the tibial baseplate. The medium tibial cone implant may sit up to 10 mm from the distal surface of the tibial implant depending on the sizes of the cone and tibial components that are selected.

Insert the corresponding medium tibial cone provisional from the final rasp size into the newly prepared area and check for proper fit (Figure 23).

Assemble the appropriate tibial baseplate provisional and stem extension provisional for which the bone has been prepared and insert through the cone to check for appropriate fit.

ⓘ **Technique Tip:** When assembling an offset stem, line up the appropriate mark on the offset stem extension provisional with the etch mark on the tibial provisional. This mark should correspond to the mark noted earlier on the offset bushing.

ⓘ **Note:** If an offset stem or a stem larger than 17 mm is to be used, assemble the medium tibial cone provisional to the tibial baseplate before attaching the stem provisional as the provisional stem will not fit through the distal aspect of the medium tibial cone.

Medium Tibial Cone Tibial Tray  
Offset Bushing Guide  
00-5452-013-25

Offset Bushing  
00-5987-004-10



## Section 1: Medium Tibial Cones

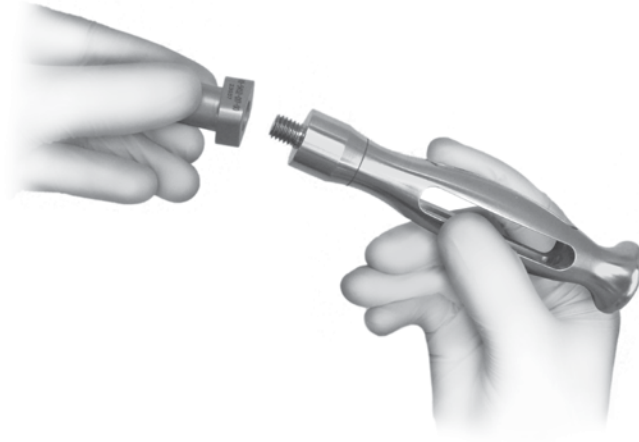

Figure 24

### Final Positioning of the Cone and Tibia

#### Implantation Technique - Cementless

**Note:** When used with the RH Knee System in the United States, the Trabecular Metal Medium Tibial Cones are for cemented use only. Please see the Cone Implantation Technique - Cemented Please see the Cone Implantation Technique - Cemented section on page 20.

Remove tibial provisionals and skeletonize the bony surfaces with pulsatile lavage to clear all residual debris.

**Note:** A 17 mm straight stem is the maximum diameter that will fit through the cone.

When using a larger stem or an offset stem, the entire construct must be pre-assembled prior to implantation. Be sure to apply bone cement to the inside surface of the cone to ensure an adequate cement mantle.

Position the final Trabecular Metal Medium Tibial Cone Implant in the tibia by hand. Assemble the medium tibial cone impactor head to the impactor handle. Position the impactor head over the Trabecular Metal Medium Tibial Cone Implant noting the anterior position on the impactor relative to the implant and tap the impactor with a mallet to seat the cone into the prepared tibial cavity (Figure 24).

Impactor Handle  
00-5451-002-00



Tibial Impactor Head-Medium  
00-5452-013-30



## Section 1: Medium Tibial Cones

### Final Positioning of the Cone and Tibia (cont.)

ⓘ **Note:** Although the cone provisional and implant are the same dimension, because the surface of the cone implant is porous, there is a higher friction fit than the provisional component.

**WARNING:** If excessive force is used to seat the implant, tibial fracture may occur.

Confirm that rotational alignment of the Trabecular Metal Medium Tibial Cone Implant is correct.

If gaps exist between the outside of the cone and the endosteal surface of the tibia, the surgeon should consider packing grafting material into any voids to encourage new bone formation and prevent cement flow into the interface between the cone and host bone when the final tibial component is cemented into position.

Properly assemble the stem extension and tibial baseplate implant in the proper orientation determined from previous trialing. Apply a sufficient amount of bone cement on the bottom of the tibial baseplate implant so that it will fill the interior of the cone implant and also fill the internal cavity of the tibia. Insert the tibial baseplate assembly into the cone. Verify correct rotational alignment and impact the implant assembly into position and remove excess bone cement.

## Section 1: Medium Tibial Cones

### Final Positioning of the Cone and Tibia (cont.)

#### Implantation Technique - Cemented

Remove tibial provisionals and skeletonize the bony surfaces with pulsatile lavage to clear all residual debris.

ⓘ **Note:** A 17 mm straight stem is the maximum diameter that will fit through the cone. When using a larger stem or an offset stem, the entire construct must be pre-assembled prior to implantation.

Apply bone cement in a low viscosity state to the outside periphery of the Trabecular Metal Medium Tibial Cone Implant and insert into the prepared tibial void. Assemble the corresponding size medium tibial cone impactor head to the impactor handle. Position the impactor head over the Trabecular Metal Medium Tibial Cone Implant and tap the impactor with a mallet to seat the cone into the prepared tibial cavity.

**WARNING:** If excessive force is used to seat the implant, tibial fracture may occur.

Confirm that rotational alignment of the Trabecular Metal Medium Tibial Cone Implant is correct.

Properly assemble the stem extension and tibial baseplate implant in the proper orientation determined from previous trialing. Apply a sufficient amount of bone cement on the bottom of the tibial baseplate implant so that it will fill the interior of the cone implant and also fill the internal cavity of the tibia. Insert the tibial baseplate assembly into the cone. Verify correct rotational alignment, impact the implant assembly into position and remove excess bone cement.

## Section 1: Medium Tibial Cones

### Removal Instructions

If removal of the Trabecular Metal Medium Tibial Cone Implant is required, first remove the tibial component and associated stem extension independent of the cone implant. If a large diameter or offset stem extension was used, it may be necessary to first detach the stem from the tibial baseplate implant as the cone implant could impede the path of removal.

Locate the periphery of the cone and use a saw to cut around the implant to break the interface between the implant and the bone, or the implant and bone cement. Care should be taken to preserve the remaining host bone during the removal process. If necessary, use a burr to break apart any remaining fixation to cone implant that cannot be accessed by a saw. Use a Kocher style instrument to grasp the implant and remove from the tibia.

## Section 2: Large Tibial Cones



Figure 25



Figure 26

### Introduction

The objective of using the Trabecular Metal Large Tibial Cone Implant is to achieve stability of the construct within the proximal tibia when bone voids are present (Figure 25). The cone that is selected must offer the ability to:

- Reinforce the cortical rim of the tibia
- Fill a proximal tibial bone void that may result from the removal of a primary knee system
- Allow the entire assembled and seated construct (cone and tibial base plate/stem extension) to provide appropriate support of the tibial baseplate

### US and Outside the United States (excluding EU) indications

The Trabecular Metal Large Tibial Cones are intended for use where severe degeneration, trauma, or other pathology of the knee joint indicates total knee arthroplasty. When used with the NexGen Complete Knee Solution – Rotating Hinge Knee (RHK) System,

the Trabecular Metal Tibial Cone Augments are for cemented use only. When used with the NexGen Complete Knee Solution – Legacy Constrained Condylar Knee System, the Trabecular Metal Large Tibial Cones are for cementless or cemented use.

### EU Indications

The Trabecular Metal Large Tibial Cones are intended for use where severe degeneration, trauma, or other pathology of the knee joint indicates total knee arthroplasty. These are not intended for primary cases.

The Trabecular Metal Large Tibial Cones are intended to be used for cementless fixation to host bone with NexGen Complete Knee Solution –Rotating Hinge Knee (RHK) and NexGen Complete Knee Solution – Legacy Constrained Condylar Knee System (LCCK). The use of cement is intended for fixation to RHK components for assembly.

In revision situations, positioning of the tibial baseplate is often dictated by the interaction of the stem extension (attached to the tibial baseplate), and the intramedullary canal. Therefore, use of offset and/or straight stem extensions should be considered during the initial cone selection process (Figure 26).



## Section 2: Large Tibial Cones

### Introduction (cont.)

The Trabecular Metal Large Tibial Cone system features instruments which reference the IM canal. This alignment feature ensures that the position of the cone does not interfere with the final position of the tibial baseplate/stem extension construct. Furthermore, the instruments help guide the surgeon in the removal of bone only to the depth that matches the cone implant and cut at a trajectory that matches the shape of the implant.

## Section 2: Large Tibial Cones Surgical Steps

### Tibial Preparation

#### Initial Proximal Tibial Resection

Ream the tibia to the appropriate diameter until rigid stability of the reamer is achieved. Remove the reamer and replace with the provisional stem of the diameter of the last reamer used with the cone alignment rod attached.

Cut the top of the tibia to the angle recommended for the tibial baseplate using the appropriate IM tibial boom and appropriate tibial cutting guide. The technique for this step in the procedure is illustrated in the NexGen LCKK and RH Knee Surgical Techniques.

It is critical that this step be performed using intramedullary alignment to ensure proper alignment between the large tibial cone and the stem of the tibial component.

## Section 2: Large Tibial Cones Surgical Steps



Figure 27

### Cone Size Evaluation

Insert the provisional stem that matches the size of the last reamer used with the cone alignment rod attached. The provisional stem should not toggle within the IM canal.

Assess the size of the tibial defect and determine the ideal size Trabecular Metal Large Tibial Cone that covers the defect (Figure 27).

**ⓘ Technique Tip:** Utilizing the large tibial cone provisionals can help to determine the appropriate size cone that covers the defect. Use the opposite side provisional upside down to get a good sense of what the final implant will cover.

Straight Stem Extension  
Provisional  
00-5989-010-10



Cone Alignment Rod  
00-5452-013-20



## Section 2: Large Tibial Cones

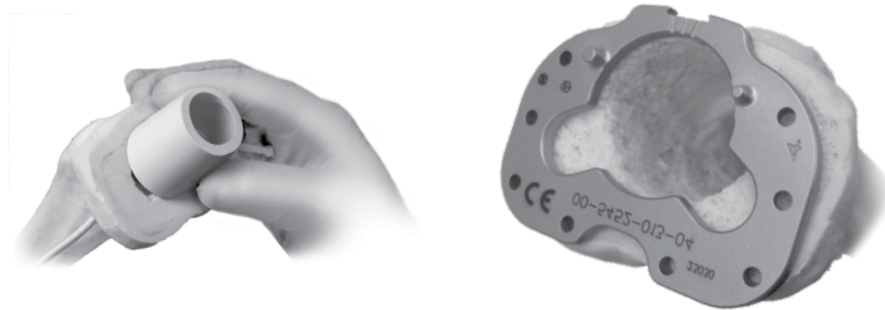

Figure 28

### Size Interchangeability and Reamer Depth Chart

Tibial Base Plate Size	Tibial Cone Size (mm)			
	51 mm x 34 mm	55 mm x 36 mm	60 mm x 36 mm	67 mm x 38 mm
LCCK Size 2	51 mm x 34 mm	55 mm x 36 mm	N/A	N/A
LCCK Size 3	51 mm x 34 mm	55 mm x 36 mm	N/A	N/A
LCCK Size 4	51 mm x 34 mm	55 mm x 36 mm	N/A	N/A
LCCK Size 5	N/A	55 mm x 36 mm	60 mm x 36 mm	N/A
LCCK Size 6	N/A	55 mm x 36 mm	60 mm x 36 mm	N/A
LCCK Size 7	N/A	N/A	60 mm x 36 mm	67 mm x 38 mm
RH Knee Size 2	51 mm x 34 mm*	55 mm x 36 mm	N/A	N/A
RH Knee Size 3	51 mm x 34 mm*	55 mm x 36 mm	60 mm x 36 mm	N/A
RH Knee Size 4	51 mm x 34 mm	55 mm x 36 mm	60 mm x 36 mm	N/A
RH Knee Size 5	51 mm x 34 mm	55 mm x 36 mm	60 mm x 36 mm	67 mm x 38 mm
RH Knee Size 6	51 mm x 34 mm	55 mm x 36 mm	60 mm x 36 mm	67 mm x 38 mm

\* Indicates combinations that can be used only with the neutral alignment setting.

Using a tibial template, check to see which size tibial component will be used. Refer to Table 2 on page 26 to ensure that the desired Tibial size and Trabecular Metal Large Tibial Cone size are compatible (Figure 28).

Medium Tibial Cone Sizing  
Template  
00-5452-013-02



Large Tibial Cone Provisional  
00-5451-013-51



## Section 2: Large Tibial Cones

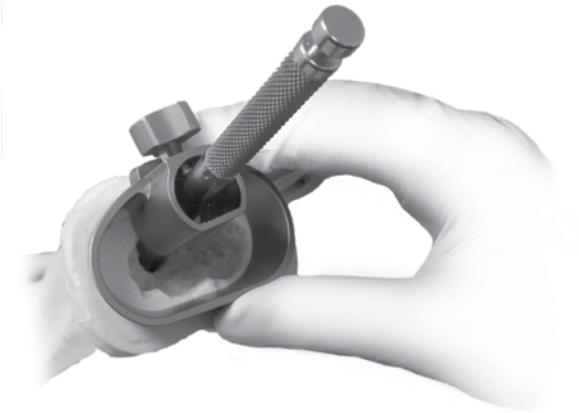

Figure 29

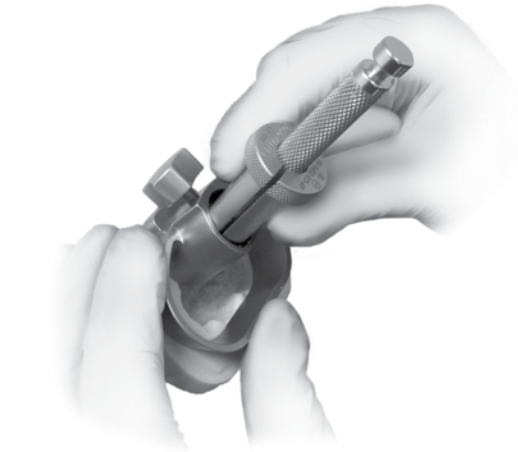

Figure 30

### Cone Size Evaluation (cont.)

After the desired cone size has been determined, select the corresponding large tibial cone burr template and place it over the cone alignment rod and onto the proximal surface of the tibia in its desired rotation (Figure 29). Insert the neutral burr template bushing over the cone alignment rod into the slot on the proximal end of the template (Figure 30).



## Section 2: Large Tibial Cones



Figure 31



Figure 32

### Cone Size Evaluation (cont.)

ⓘ **Note:** If the tibia has been cut with posterior slope, the tibial milling guides will sit off the tibial plateau in the posterior region (Figure 31).

The system also offers an offset burr template bushing. This allows the large tibial cone burr template to be translated 2 mm in a medial or lateral direction. The offset burr template bushing can be used to translate the large tibial cone burr template in a medial or lateral direction by rotating it 180 degrees before inserting it into the proximal slot of the template.

ⓘ **Technique Tip:** Should the selected size tibial cone burr template not completely cover the bone void in one direction, check to see if offsetting the template will cover the defect before selecting a larger size.

When the large tibial cone burr template has been positioned in its desired orientation, tighten the anterior set screw to lock the large tibial cone burr template to the cone alignment rod (Figure 32).



## Section 2: Large Tibial Cones

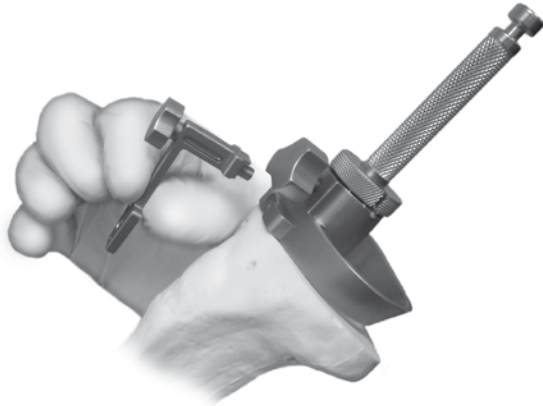

Figure 33



Figure 34

### Cone Size Evaluation (cont.)

Additional pin fixation can be achieved by sliding the burr template fixation plate into the anterior slot and locking it in place by tightening the screw (Figure 33).

**🔑 Technique Tip:** For most effective pin fixation, use the angled holes that allow the pin to enter the tibia on the medial side in a more perpendicular angle. In the face of dense sclerotic bone, it is recommended to drill holes for the pins in order to reduce the risk of fracture.

Headless holding pins from the NexGen LCCK or RH Knee Instrument Sets can now be inserted through the burr template fixation plate for additional stability (Figure 34).



## Section 2: Large Tibial Cones

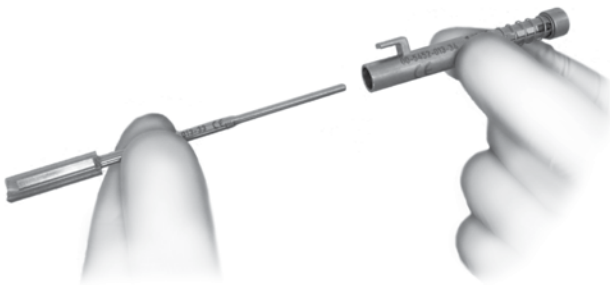

Figure 35

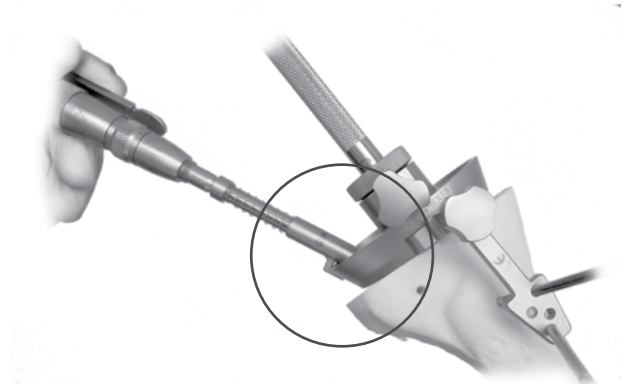

Figure 36

### Preparing the Bone

**Note:** Two different burr guards are provided in the set. The 7° Guard is used when implanting the 7° NexGen Tibial Baseplate. The 0° guard is used when implanting the NexGen A/P Wedge or RH Knee Tibial Baseplates.

Slide the appropriate burr guard over the burr and attach the assembly to the burr hand piece (Figure 35).

**Note:** The burr is compatible with milling hand pieces that accept a 2.34 mm burr shank. These are equivalent to the MicroAire Series 1000 Air Motor Module with Model 1930 Micro Drill Head Module.

Position the large tibial cone burr on the inside of the large tibial cone burr template and allow the hook to engage the track of the large tibial cone burr template of the burr guard. Begin burring out the remaining bone inside of the burr template carefully following the capture track taking care to maintain the correct angle (Figure 36). Two hand stabilization of the handpiece is recommended to facilitate bone preparation.

**Be sure to thoroughly irrigate while burring.**

Large Tibial Cone Burr  
(single use)  
00-5452-013-71

Large Tibial Cone  
00-5452-013-34





## Section 2: Large Tibial Cones

### Preparing the Bone (cont.)

⊖ **Technique Tip:** When burring, ensure that the burr guard is in constant contact with the proximal edge of the burring rail. Since the burr guard does not rotate, it can help to guide the burr construct by grasping the sleeve with one's off hand and guiding it around the capture track.

The design of the large tibial cone burr template will allow for a captured burr cut in the medial, posterior, and lateral aspects of the tibia. The anterior aspect of the cuts will need to be finished by hand due to the interference of the intramedullary stem. Additionally, due to the cone's anatomic shape, the captured aspect of the cut will not reach the proper depth on the medial and lateral side.

## Section 2: Large Tibial Cones

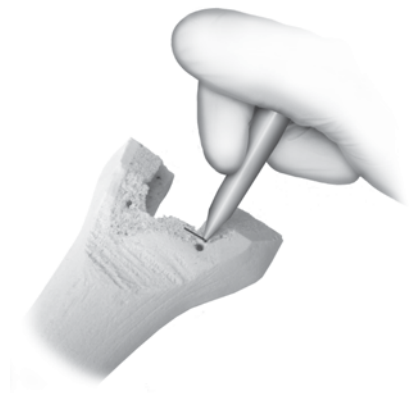

Figure 37

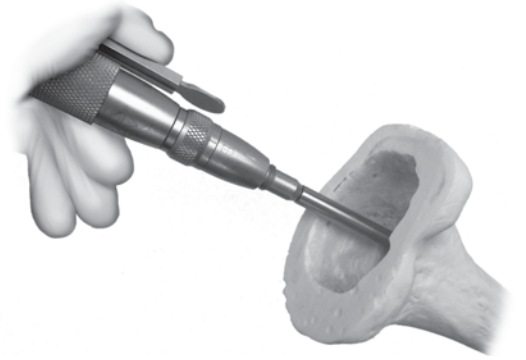

Figure 38

### Preparing the Bone (cont.)

To finish the anterior portion of the bone preparation and to establish the proper depth, first remove the large tibial cone burr template construct along with the provisional stem. Use the opposite side provisional large tibial cone and flip it upside down on the tibia so that its outer diameter traces the periphery of the cut that has been made. Ensure that the cone orientation is correct by referencing the ANTERIOR mark on the cone. With methylene blue or a bovie, trace around the outside of the provisional where bone remains. This line will serve as a guide to finish the cut (Figure 37).

Remove the burr guard and replace it with the large tibial cone burr sleeve. This burr sleeve allows the burr to lay flat on the existing cut which can be used as a guide when removing the remaining bone.

The proper depth of the cut is indicated by the posterior aspect of the cut. Maintaining a flush contact between the finishing burr sleeve and the already prepared medial and lateral aspects will ensure the proper trajectory for hand finishing. Take note of the inclination of the anterior portion of the provisional implant to use as a guide for removing the remaining anterior bone (Figure 38).

## Section 2: Large Tibial Cones



Figure 39

### Preparing the Bone (cont.)

Insert the prepared size large tibial cone provisional by hand to assess the fit in the tibial bone. Remove any excess bone with the burr in order for the cone provisional to seat properly (Figure 39).



## Section 2: Large Tibial Cones



Figure 40

### Final Positioning of Cone in the Tibia

#### Implantation Technique - Cementless

**Note:** When used with the RH Knee System in the United States, the Trabecular Metal Large Tibial Cones are for cemented use only. See the Implantation Technique - Cemented section on page 36.

When using a 16 mm or larger straight stem, the Trabecular Metal Large Tibial Cone Implant must be pre-assembled to the tibial baseplate prior to implantation. These components will always need to be pre-assembled when using offset stems.

Remove all provisionals and instruments and skeletonize the bony surfaces with pulsatile lavage to clear all residual debris.

Position the selected size Trabecular Metal Large Tibial Cone Implant in the tibia by hand. Assemble the corresponding size large tibial cone impactor head to the impactor handle. Position the impactor head over the Trabecular Metal Large Tibial Cone Implant and tap the impactor with a mallet to seat the cone into the prepared tibial cavity (Figure 40). It should be noted that although the cone provisional and implant are the same dimension, the surface of the cone implant is porous and therefore has a higher friction fit than the provisional component.

**WARNING:** If excessive force is used to seat the implant, tibial fracture may occur.

Mallet  
00-0155-002-00



Impactor Handle  
00-5451-002-00



Large Tibial Cone  
Impactor Head  
00-5452-013-35



## Section 2: Large Tibial Cones

### Final Positioning of Cone in the Tibia (cont.)

Confirm that rotational alignment of the large tibial cone is correct.

If gaps exist between the outside of the cone and the endoseal surface of the tibia, the surgeon may consider packing grafting material into these areas.

It is recommended that a last trial of the provisional tibial implant assembly be conducted prior to cementing the final implants.

⊖ **Technique Tip:** Use of the provisional tibial component and stem extension as a final impaction tool can help ensure proper seating of the cone and correct alignment of the tibial component.

⊖ **Note:** After you have achieved the desired position for the provisional tibial cone, it is helpful to check an x-ray with the provisional tibial baseplate and stem in place to ensure proper positioning of the cone and correct alignment of the tibial component.

Assemble the stem extension and tibial baseplate implant in the proper orientation decided from previous trialing. Apply a sufficient amount of bone cement on the bottom of the tibial baseplate implant so that it will fill the interior of the cone implant and also fills the internal cavity of the tibia. Insert the tibial baseplate implant assembly into the cone. Verify correct rotational alignment and impact the implant assembly into position and remove excess bone cement.

## Section 2: Large Tibial Cones

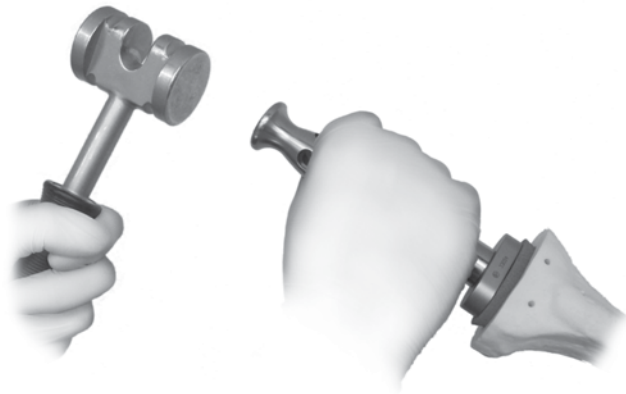

Figure 41

### Final Positioning of Cone in the Tibia (cont.)

#### Implantation Technique - Cementless

Remove tibial trials and skeletonize the bony surfaces with pulsatile lavage to clear all residual debris.

When using a 16 mm or larger straight stem, the Trabecular Metal Large Tibial Cone Implant must be pre-assembled to the tibial baseplate implant prior to implantation. These components will always need to be pre-assembled when using offset stems.

Apply bone cement in the low viscosity state to the outside periphery of the Trabecular Metal Large Tibial Cone Implant and insert into the prepared tibial void. Assemble the corresponding size large tibial cone impactor head to the impactor handle. Position the impactor head over the Trabecular Metal Large Tibial Cone Implant and tap the impactor with a mallet to seat the cone into the prepared tibial cavity (Figure 41)

**WARNING:** If excessive force is used to seat the implant, tibial fracture may occur.

Confirm that rotational alignment of the Trabecular Metal Large Tibial Cone Implant is correct.

Assemble the stem extension and tibial baseplate implant in the proper orientation decided from previous trialing. Apply a sufficient amount of bone cement on the bottom of the baseplate implant plate so that it will fill the interior of the cone implant and also fills the internal cavity of the tibia. Insert the tibial baseplate implant assembly into the cone. Verify correct rotational alignment and impact the implant assembly into position and remove excess bone cement.

## Section 2: Large Tibial Cones

### Removal Instructions

If removal of the Trabecular Metal Large Tibial Cone Implant is required, first remove the tibial component and associated stem extension independent of the cone implant. If a large diameter or offset stem extension was used, it may be necessary to first detach the stem from the tibial baseplate implant as the cone implant could impede the path of removal.

Locate the periphery of the cone and use a saw to cut around the implant to break the interface between the implant and the bone, or the implant and bone cement. Care should be taken to preserve the remaining host bone during the removal process. If necessary, use a burr to break apart any remaining fixation to cone implant that cannot be accessed by a saw. Use a Kocher style instrument to grasp the implant and remove from the tibia.

## Section 3: Diaphyseal Femoral Cones



Figure 42

### Introduction

The objective of the Trabecular Metal Diaphyseal Femoral Cone Implant (Figure 42) is to fill and reconstruct large bone deficiencies and cavitory defects in the diaphysis of the distal femur, and to provide a stable platform for the support of a NexGen LCCK or RH Knee femoral component.

### US and Outside the United States (excluding EU) indications

The Trabecular Metal Diaphyseal Femoral Cones are intended for use where severe degeneration, trauma, or other pathology of the knee joint indicates total knee arthroplasty. When used with the NexGen Complete Knee Solution – Rotating Hinge Knee (RHK) System, the Trabecular Metal Diaphyseal Femoral Cones are for cemented use only. When used with the NexGen Complete Knee Solution – Legacy Constrained Condylar Knee System, the Trabecular Metal Diaphyseal Femoral Cone Augments are for cementless or cemented use.

### EU Indications

The Trabecular Metal Diaphyseal Femoral Cones are intended for use where severe degeneration, trauma, or other pathology of the knee joint indicates total knee arthroplasty. These are not intended for primary cases.

The Trabecular Metal Diaphyseal Femoral Cones are intended to be used for cementless fixation to host bone with NexGen Complete Knee Solution –Rotating Hinge Knee (RHK) and NexGen Complete Knee Solution –Legacy Constrained Condylar Knee System (LCCK). The use of cement is intended for fixation to RHK components for assembly.

### The Trabecular Metal Diaphyseal Femoral Cone Implant that is selected must:

1. Fit within the damaged area of the femoral diaphysis without unnecessary removal of viable bone.
2. Allow the selected femoral component and associated stem extension to be inserted through the Trabecular Metal Diaphyseal Femoral Cone Implant and positioned within the medullary canal.
3. Allow the selected Trabecular Metal Diaphyseal Femoral Cone Implant to be positioned proximal to the femoral component box independent of the intended joint line in order to properly fill the defect.



## Section 3: Diaphyseal Femoral Cones



Figure 43

### Introduction (cont.)

The design of the Trabecular Metal Diaphyseal Femoral Cone is asymmetric. There are left and right configurations available in Small, Medium and Large sizes at 30 mm in height.

The femur and associated bony defect must be prepared to accommodate the Trabecular Metal Diaphyseal Femoral Implant, the NexGen LCKK or RH Knee Femoral Component and the associated stem extension. The femur is prepared via a sequential process of broaching bone while assessing fit and stability with provisional implants (provisionals). Repeated trialing of various potential implant combinations should be performed to optimize:

1. The fit and stability of the Trabecular Metal Diaphyseal Femoral Cone Implant with minimum removal of viable bone stock
2. The fit of the stem extension within the femoral canal
3. The position of the NexGen LCKK or RH Knee Femoral Component on the Trabecular Metal Diaphyseal Femoral Cone Implant

## Section 3: Diaphyseal Femoral Cones Surgical Steps

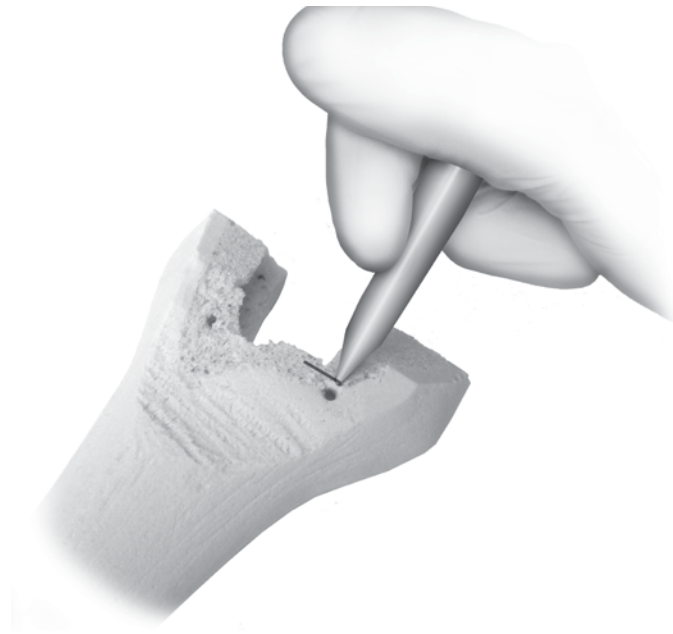

Figure 44

### Distal Femur Preparation

Prepare for the distal femur using the techniques detailed in the NexGen LCCK or RH Knee surgical protocols. Be sure to prepare for the stem of the femoral component and to make all bone cuts which accommodate the box of the selected femoral implant.

When cutting for the box of the femoral component, ensure that the proximal aspect of the box is visible. If the proximal aspect cannot be easily determined due to a bony defect, mark a line with a bovie or methylene blue where the proximal cut would be on the bone. This will be important when determining how deep to impact the femoral broach (Figure 44).

Ream the femoral canal to the appropriate depth of the selected stem extension and diameter until stability of the reamer is achieved.

In order maximize drill/reamer preparation and minimize broach preparation for the Trabecular Metal Diaphyseal Femoral Cone, use the 20 mm reamer to ream about 35 mm past the most proximal femoral box preparation cut.

## Section 3: Diaphyseal Femoral Cones Surgical Steps

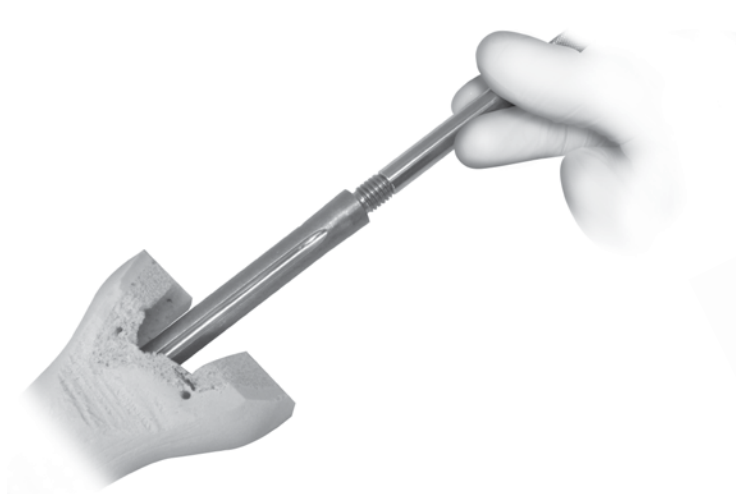

Figure 45



Figure 46

### Distal Femur Preparation (cont.)

Select the provisional stem that matches the last reamer used (prior to the cone prep with the 20 mm reamer), and attach it to the cone alignment rod. (Figure 45). Slide this construct into the medullary canal to its appropriate stem depth (Figure 46). The provisional stem must be stable within the canal.

**Cone Alignment Rod**  
00-5425-013-20



**Large Tibial Cone**  
00-5989-010-10



## Section 3: Diaphyseal Femoral Cones



Figure 47



Figure 48

### Broach to the Appropriate Cone Size

Begin with the correct side small diaphyseal femoral cone broach and slide it over the cone alignment rod (Figure 47). Position the broach so that the anterior side of the broach is parallel with the anterior cut of the femur. This is critical as there is very little rotational freedom between the cone and the femoral component (Figure 48).



## Section 3: Diaphyseal Femoral Cones

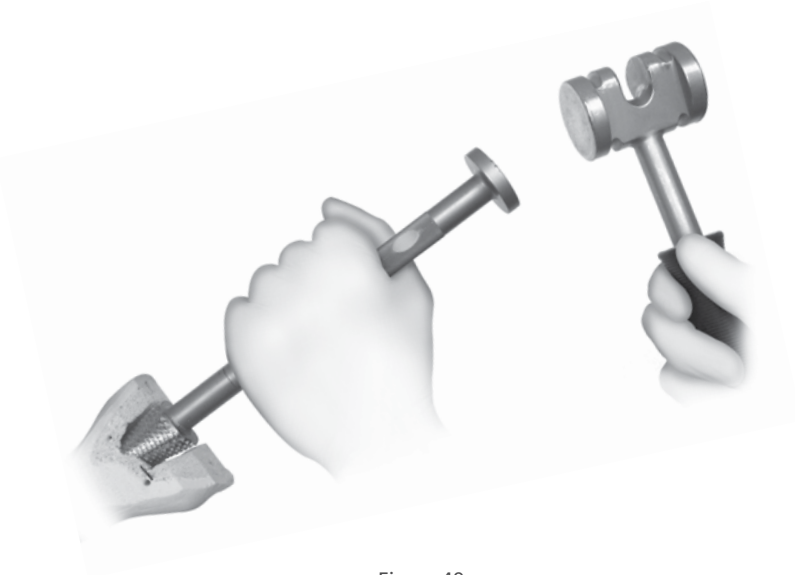

Figure 49



Figure 50

### Broach to the Appropriate Cone Size (cont.)

Impact the broach with a mallet over the cone alignment rod into the femur while making sure to maintain the correct orientation. Continue to impact the broach until the entire broach head has passed the proximal box cut (Figure 49). If necessary, the broach can be impacted deeper to fill the defect (Figure 50).

If the broach does not sit stable in the defect, consider using the next larger size broach and repeat the previous broaching steps.

- ⊖ Technique Tip:** Should the largest size Trabecular Metal Diaphyseal Femoral Cone Implant be insufficient to fill a large cavitory defect in a compromised femur, consider the use of a distal femoral segmental replacement device.



### Section 3: Diaphyseal Femoral Cones

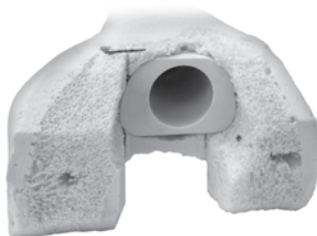

Figure 52

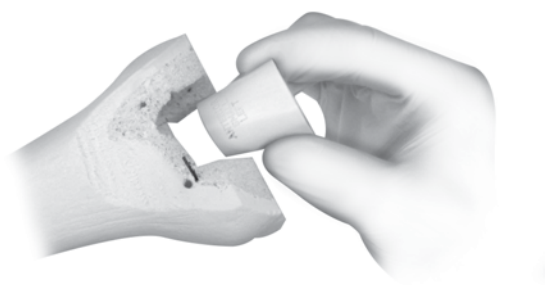

Figure 51



Figure 53

#### Broach to the Appropriate Cone Size (cont.)

Position the selected size provisional diaphyseal femoral cone in the prepared defect to check for proper fit and orientation (Figure 51 and 52).

To remove the provisional, use the provisional cone extractor tool which will attach to the provisional from the inside (Figure 53).

Diaphyseal Femoral Cone  
Provisional  
00-5451-017-30



Provisional Extractor  
00-5451-006-10



## Section 3: Diaphyseal Femoral Cones



Figure 54

### Provisional Stem Extension Selection

**Note:** Only straight stems can be used with the Trabecular Metal Diaphyseal Femoral Cone. Offset stems will not fit through the cone implant.

Zimmer Biomet revision knee systems have several choices of stem extension components, in both sharp fluted and cemented designs, and in various lengths which are detailed in the NexGen LCCK and RH Knee Surgical Techniques.

Critical in the stem selection process is the recognition that the entire assembly of components must be accommodated simultaneously in the distal femur. Note the maximum stem diameters that can fit through each size cone below:

- Small – 16 mm maximum diameter
- Medium – 16 mm maximum diameter
- Large – 17 mm maximum diameter

### Trial positioning of the Assembly

Assemble the combination of the selected stem extension provisional, selected femoral component provisional (with distal and posterior provisional augments attached, if necessary). Insert the provisional cone into the cavitory lesion of the distal femur either by hand or with the inserter tool. Next, insert the provisional femoral component (with the stem extension provisional attached) through the provisional cone into the femoral canal. Assess the construct for proper fit and alignment on the distal femur (Figure 54).

## Section 3: Diaphyseal Femoral Cones

### Filling Gaps Outside of the Cone

If gaps exist between the outer envelope of the diaphyseal femoral cone provisional and the endosteal surface of the femur, packing the voids with particulate bone graft material should be considered. The diaphyseal femoral cone provisional is then positioned in the distal femur to the intended depth. If necessary, pack morselized grafting material behind the provisional augment, and then re-insert.

The rationale for the placement of this morselized bone graft is for the augmentation of local bone stock, not for structural bone support. The Trabecular Metal Diaphyseal Femoral Cone Implant should be of sufficient size that its contact with the host bone imparts stability that is not dependent on structural allografting for that stability.

### Final Trialing

It is recommended that a final trial reduction of the entire construct of the femoral component provisional/diaphyseal cone provisional/provisional stem be conducted prior to implanting the devices. If satisfactory, remove the diaphyseal femoral cone provisional - taking care to not disturb any graft material between the outside of the diaphyseal femoral cone provisional and endosteal surface.



## Section 3: Diaphyseal Femoral Cones

### Final Positioning of the Cone in the Femur

#### Implantation Technique – Cementless

- ⓘ **Note:** When used with the RH Knee System in the United States, the Trabecular Metal Diaphyseal Femoral Cone Implants are for cemented use only. See the Implantation Technique - Cemented section on page 50 for implantation using cement.
- ⓘ **Note:** When the cones are used without bone cement, it is extremely important that adequate host bone quantity and quality is present to stabilize and support the Trabecular Metal Diaphyseal Femoral Cone and associated components.

## Section 3: Diaphyseal Femoral Cones



Figure 55

### Implantation Technique – Cementless (cont.)

Position the selected Trabecular Metal Diaphyseal Femoral Cone Implant into the prepared space by hand. Assemble the diaphyseal femoral cone impactor to the impactor handle and position the tool on the surface of the Trabecular Metal Diaphyseal Femoral Cone Implant (Figure 55). Check to be sure that the impactor head sits flush against the Trabecular Metal Diaphyseal Cone Implant. Tap the impactor with a mallet to seat the cone into the prepared femoral cavity. Take care to replicate the rotational alignment of the implant as well as its depth of insertion.

**Note:** In the face of rotational malalignment, over penetration in depth of seating, or in the face of

excessive force used to seat the implant, femoral fracture may occur.

Because of the high surface friction of Trabecular Metal Material against bone, the fit of the Trabecular Metal Femoral Cone Implant may be tighter than that determined with the provisional. If necessary, bone graft material and/or additional bone may need to be removed to fully seat the Trabecular Metal Diaphyseal Femoral Cone Implant to the level originally indicated during the final trialing step. Upon final seating, the interface between the Trabecular Metal Material and bone should be in intimate contact and free of gaps and voids.

**WARNING:** If excessive force is used to seat the implant, femoral fracture may occur.

Confirm that rotational alignment of the Trabecular Metal Diaphyseal Femoral Cone Implant is correct.

Impactor Handle  
00-5451-002-00



Diaphyseal Femoral Cone Impactor Head  
00-5452-017-10



## Section 3: Diaphyseal Femoral Cones

### Implantation Technique – Cementless (cont.)

Add cement to the final femoral component construct and implant through the Trabecular Metal Diaphyseal Femoral Cone Implant.

ⓘ **Note:** The entire inside volume of the Trabecular Metal Diaphyseal Femoral Cone Implant elongated hole must be filled with cement.

Implant the final femoral component with stem extension through the cone and impact as described in the NexGen LCKK or RH Knee Surgical Techniques.

## Section 3: Diaphyseal Femoral Cones

### Final Positioning of the Cone in the Femur (cont.)

#### Implantation Technique – Cemented

Apply bone cement in the low viscosity state to the outside periphery of the Trabecular Metal Diaphyseal Femoral Cone Implant.

Position the selected Trabecular Metal Diaphyseal Femoral Cone Implant into the prepared space by hand. Assemble the diaphyseal femoral cone impactor to the impactor handle and position the tool on the surface of the cone. Check to be sure that the impactor head sits flush against the Trabecular Metal Diaphyseal Cone Implant. Tap the impactor with a mallet to seat the cone into the prepared femoral cavity. Remove only excess bone cement.

**WARNING:** If excessive force is used to seat the implant, femoral fracture may occur.

Confirm that rotational alignment of the Trabecular Metal Diaphyseal Femoral Cone Implant is correct.

If necessary, assemble any selected distal or posterior augments, along with the stem extension to the NexGen LCCK or RH Knee Femoral Implant. Form a “cone” of bone cement on the interior surface of the femoral component (including the intercondylar box region and up the stem extension of the femoral component). The amount of cement must be of sufficient quantity to fill the internal cavity of the cone.

**Note:** The entire inside volume of the Trabecular Metal Diaphyseal Femoral Cone Implant elongated hole must be filled with cement.

Implant the final femoral component with stem extension through the cone and impact as described in the NexGen LCCK or RH Knee Surgical Techniques.

## Section 3: Diaphyseal Femoral Cones

### Removal Instructions

If removal of the Trabecular Metal Diaphyseal Femoral Cone Implant is required, first remove the femoral component and associated stem extension independent of the cone implant. If a large diameter stem extension was used, it may be necessary to first detach the stem from the femoral component as the cone implant could impede the path of removal.

Locate the periphery of the cone and use a saw to cut around the implant to break the interface between the implant and the bone, or the implant and bone cement. Care should be taken to preserve the remaining host bone during the removal process. If necessary, use a burr to break apart any remaining fixation to cone implant that cannot be accessed by a saw. Use a Kocher style instrument to grasp the implant and remove from the femur.

## Section 4: Metaphyseal Femoral Cones



Figure 56

### Introduction

The objective of the Trabecular Metal Metaphyseal Femoral Cone is to fill and reconstruct large bone deficiencies and cavitory defects in the distal femur and to provide a stable platform for a NexGen LCCK or RH Knee Femoral Component (Figure 56).

#### US and Outside the United States (excluding EU) indications

The Trabecular Metal Metaphyseal Femoral Cones are intended for use where severe degeneration, trauma, or other pathology of the knee joint indicates total knee arthroplasty. When used with the NexGen Complete Knee Solution – Rotating Hinge Knee (RHK) System, the Trabecular Metal Tibial Cone Augments are for cemented use only. When used with the NexGen Complete Knee Solution – Legacy Constrained Condylar Knee System, the Trabecular Metal Metaphyseal Femoral Cones are for cementless or cemented use.

#### EU Indications

The Trabecular Metal Metaphyseal Femoral Cones are intended for use where severe degeneration, trauma, or other pathology of the knee joint indicates total knee arthroplasty. These are not intended for primary cases.

The Trabecular Metal Metaphyseal Femoral Cones are intended to be used for cementless fixation to host bone with NexGen Complete Knee Solution – Rotating Hinge Knee (RHK) and NexGen Complete Knee Solution – Legacy Constrained Condylar Knee System (LCCK). The use of cement is intended for fixation to RHK components for assembly.

#### The Trabecular Metal Metaphyseal Femoral Cone that is selected must:

- Reinforce the damaged area of the femoral cavity without significant removal of viable bone
- Allow the selected femoral component and stem extension to be inserted through the cone and positioned into the femoral canal
- Accommodate the femoral component and stem extension assembly to stabilize and reconstruct the distal femur in order to transfer and distribute load to distal femoral bone with sufficient structural integrity to support a total knee replacement
- Allow for adjustments of femoral component rotation to re-establish appropriate epicondylar axis alignment

## Section 4: Metaphyseal Femoral Cones



Figure 57

### Introduction (cont.)

The design of the Trabecular Metal Femoral Cone is asymmetric, with left and right configurations available in small, medium and large sizes.

The femur and associated bony defect must be prepared to accommodate the Trabecular Metal Metaphyseal Femoral Cone and NexGen LCCK or RH Knee Femoral Component with an associated stem extension (Figure 57). The femur is prepared via an iterative process of removing and sculpting bone and assessing fit and stability with the provisional implants.

### Repeated trialing of various potential implant combinations should be performed to optimize:

1. The fit and stability of the Trabecular Metal Metaphyseal Femoral Cone with minimal removal of viable bone stock
2. The fit of the stem extension within the femoral IM canal
3. The position of the NexGen LCCK or RH Knee Femoral Component

## Section 4: Metaphyseal Femoral Cones

### Distal Femur Preparation

Prepare for the distal femur using the techniques detailed in the NexGen LCCK or RH Knee Surgical Techniques. Be sure to prepare for the stem of the femoral component and to make all bone cuts which accommodate the box of the selected femoral implant.

### Stem Extension Provisional Selection

The NexGen LCCK and RH Knee Systems have several choices of stem extension components, in both sharp fluted and cemented designs, and in various lengths.

Critical in the stem selection process is the recognition that the entire assembly of components must be accommodated simultaneously in the distal femur. Note the maximum stem diameters that can fit through each size cone below:

- Small – 16 mm maximum diameter
- Medium – 16 mm maximum diameter
- Large – 17 mm maximum diameter

Use of a larger diameter stem or an offset stem will require the cone and the femoral component to be unitized with cement prior to implantation.



## Section 4: Metaphyseal Femoral Cones

### Stem Extension Provisional Selection (cont.)

🔑 **Technique Tip:** The smaller the diameter of the stem extension, the greater the flexibility of positioning the metaphyseal femoral cone relative to the femoral component.

Sequentially ream the femoral IM canal to the appropriate depth and diameter of the selected stem until rigid stability of the reamer is achieved. Remove the reamer and note the diameter and prepared depth.

Select the appropriate diameter stem extension provisional and attach it to the cone alignment rod. Insert the provisional stem construct into the intramedullary canal. The provisional stem should be stable within the IM canal.

---

**Straight Stem Extension Provisional**  
00-5989-010-10



**Cone Alignment Rod**  
00-5452-013-20



## Section 4: Metaphyseal Femoral Cones

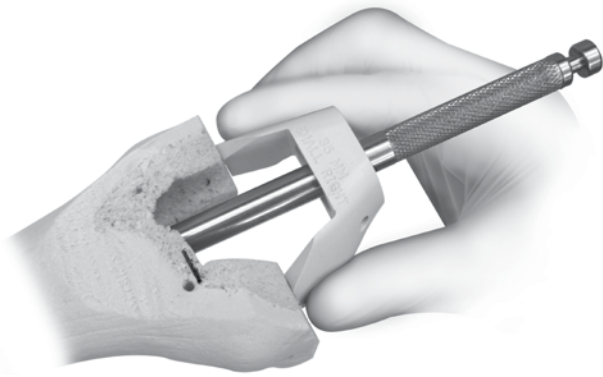

Figure 58



Figure 59

### Femoral Cone Size Selection

Select the correct side metaphyseal femoral cone provisional that approximates the size and depth of the defect and insert it over the stem extension provisional to check for size and position relative to the IM canal.

**ⓘ Technique Tip:** Invert the opposite side metaphyseal femoral cone provisional to simulate the size of the distal void that the cone will accommodate. This will help provide an estimate of the A/P and M/L position of the defect, relative to the center of the IM canal (Figure 58).

Assemble the combination of the selected stem extension provisional and femoral component provisional (with posterior augment provisionals attached, if necessary). Insert the metaphyseal femoral cone provisional into the femoral void. Next, attempt to insert the provisional femoral component (with the stem extension provisional attached) through the provisional cone, into the femoral canal. Determine if a different combination of one or more of the provisional components is necessary to achieve stability while minimizing bone loss and optimizing femoral cone fit and stability (Figure 59).



## Section 4: Metaphyseal Femoral Cones

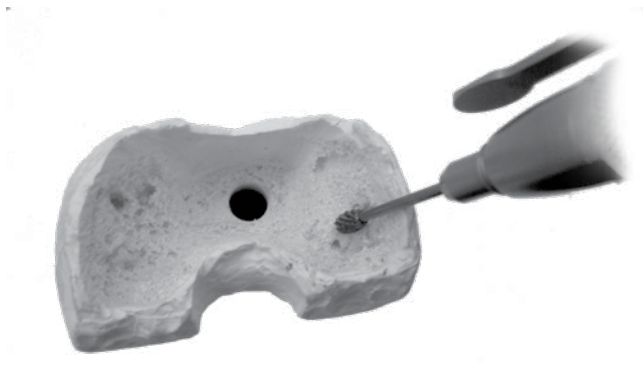

Figure 60



Figure 61

### Metaphyseal Femoral Cones

Remove the provisional femoral construct and using a high-speed burr, excess endosteal bone from the distal femur in order to allow the selected metaphyseal femoral cone (and then the full construct) to properly seat within the distal femur (Figure 60).

Repeat this step as necessary. Frequently confirm that the assembled provisional components can be inserted into the canal while the cone and femoral provisional assembly is properly positioned within the distal femur. Care must be taken to confirm alignment in all planes of the femoral component during this process (Figure 61).

## Section 4: Metaphyseal Femoral Cones

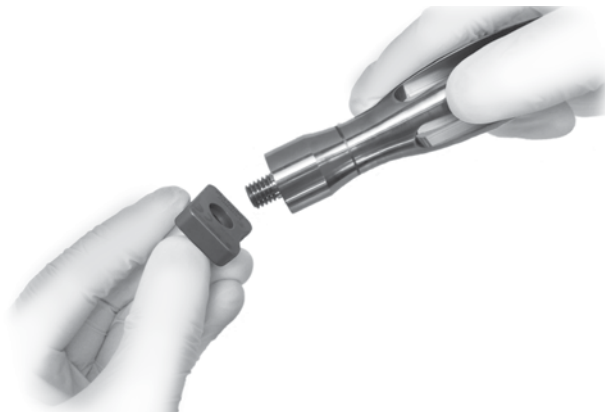

Figure 62

### Final Trialing

It is recommended that a final trial of the entire construct be conducted prior to implanting. If satisfactory, remove the provisional femoral cone - taking care to not disturb any graft material between the outside of the provisional cone and endosteal surface.

### Final Positioning of the Cone in the Femur

#### Implantation Technique – Cementless

ⓘ **Note:** When used with the NexGen RH Knee in the United States, the Trabecular Metal Metaphyseal Cone Implants are for cemented use only. See the Implantation Technique - Cemented section on page 60 for implantation using cement.

Gaps at the interfaces between the Trabecular Metal Material and bone may be filled with bone graft materials. The stability and fit of the femoral cone is assessed via iterative bone removal, sculpting, grafting procedures, and trialing with the provisional femoral cones.

Once stability and adequate support is confirmed with the provisional femoral cone, the Trabecular Metal Metaphyseal Femoral Cone Implant is inserted by hand. Attach the cone impactor handle to the metaphyseal femoral cone impactor head (Figure 62).

Impactor Handle  
00-5451-002-00



Diaphyseal Femoral Cone Impactor Head  
00-5451-008-00



## Section 4: Metaphyseal Femoral Cones



Figure 63

### Final Positioning of the Cone in the Femur (cont.)

#### Implantation Technique – Cementless

Position the femoral cone impactor on the distal end of the implant and tap the cone into place using the mallet on the impactor handle (Figure 63).

**WARNING:** If excessive force is used to seat the implant, femoral fracture may occur.

Confirm that rotational alignment of the Trabecular Metal Metaphyseal Cone Implant is correct.

Because of the high friction of Trabecular Metal Material against bone, the fit of the Trabecular Metal Metaphyseal Femoral Cone Implant may be tighter than that determined with the provisional. If necessary, bone graft material and/or bone may need to be removed to fully seat the Trabecular Metal Metaphyseal Femoral Cone Implant. Upon final seating, the interfaces between the Trabecular Metal Material and bone should be in intimate contact and free of gaps and voids.

Implant the final femoral component with stem extension through the cone and impact as described in the NexGen LCCK or RH Knee Surgical Techniques.

## Section 4: Metaphyseal Femoral Cones

### Final Positioning of the Cone in the Femur (cont.)

#### Implantation Technique – Cemented

Apply bone cement to the outside periphery of the Trabecular Metal Metaphyseal Femoral Cone Implant while in the low viscosity state. Attach the cone impactor handle to the metaphyseal femoral cone impactor head.

Insert the femoral cone in the prepared space and position the femoral cone impactor on the distal end of the implant. Using the mallet, gently tap on the femoral cone impactor handle to insert the implant into the prepared femoral void and remove excess bone cement.

**WARNING:** If excessive force is used to seat the implant, femoral fracture may occur.

Confirm that rotational alignment of the Trabecular Metal Metaphyseal Cone Implant is correct.

The amount and viscosity of the bone cement may cause a tighter fit than that associated with the provisional.

⊖ **Technique Tip:** Application of cement and implantation of the early in the polymerization process is strongly recommended to reduce the risk of fracture.

Implant the final femoral component with stem extension through the cone and impact as described in the NexGen LCCK or RH Knee Surgical Techniques.

## Section 4: Metaphyseal Femoral Cones

### Removal Instructions

If removal of the Trabecular Metal Metaphyseal Femoral Cone Implant is required, first remove the femoral component and associated stem extension independent of the cone implant. If a large diameter or offset stem extension was used, it may be necessary to first detach the stem from the femoral component as the cone implant could impede the path of removal.

Locate the periphery of the cone and use a saw to cut around the implant to break the interface between the implant and the bone, or the implant and bone cement. Care should be taken to preserve the remaining host bone during the removal process. If necessary, use a burr to break apart any remaining fixation to cone implant that cannot be accessed by a saw. Use a Kocher style instrument to grasp the implant and remove from the femur.

Zimmer Biomet does not practice medicine. This technique was developed in conjunction with health care professionals. This document is intended for surgeons and is not intended for laypersons. Each surgeon should exercise his or her own independent judgment in the diagnosis and treatment of an individual patient, and this information does not purport to replace the comprehensive training surgeons have received.

As with all surgical procedures, the technique used in each case will depend on the surgeon's medical judgment as the best treatment for each patient. Results will vary based on health, weight, activity and other variables. Not all patients are candidates for this product and /or procedure.

All content herein is protected by copyright, trademarks, and other intellectual property rights, as applicable, owned by or licensed to Zimmer Biomet or its affiliates unless otherwise indicated, and must not be redistributed, duplicated or disclosed, in whole or in part, without the express written consent of Zimmer Biomet.

This material is intended for health care professionals. Distribution to any other recipient is prohibited.

For indications, contraindications, warnings, precautions, potential adverse effects and patient counseling information, see the package insert or contact your local representative; visit [www.zimmerbiomet.com](http://www.zimmerbiomet.com) for additional product information.

Caution: Federal (USA) law restricts this device to sale by or on the order of a surgeon. Rx only.

Check for country product clearance and reference product specific instructions for use.

Not for distribution in France.

© 2020 Zimmer Biomet



97-5450-009-00-REV2-0120

 **Legal Manufacturer**  
Zimmer Trabecular Metal Technology, Inc.  
10 Pomeroy Road  
Parsippany, New Jersey 07054  
USA

[www.zimmerbiomet.com](http://www.zimmerbiomet.com)



CE mark on a surgical technique is not valid unless there is a CE mark on the product label.